

# Hawa Concepta III for wooden folding/sliding doors

## Flowing transitions make rooms more flexible than ever before

---

Hawa Concepta III supports the trend towards open living spaces, and creates transitions from kitchen to living room or from workplace to living area in a more fluid way than ever before.

Doors of any size can be pivoted, slid in sideways and parked in an extremely small space, almost in the blink of an eye.

They can then be brought out again with a gentle tap and closed flush with the surface, so that all that remains visible of the kitchen is an aesthetic front. This works so easily and intuitively that it is even possible to dispense with handles.





We weren't just thinking about the users during the development of the Hawa Concepta III: The system impresses with its simplicity, even during installation and adjustment. This is all based on technology that is just as invisible as a kitchen that is currently not in use.



### Area of application

Cabinet constructions for multi-functional use of rooms which contain kitchens, home offices, washer/dryer combinations and storage space, which are freely accessible and disappear behind the cabinet front with pivot / slide-in hardware if required.

### System advantages

-  **Flexibility** Variable door dimensions: **half-height to floor-to-ceiling solutions** possible, including **walk-on solutions**
-  **Productivity** **Easy installation** thanks to high degree of pre-assembly  
**Intuitive adjustment** with easily accessible adjustment points
-  **Comfort** **Ergonomic movement support** for even, smooth movement  
**Opening and closing with very little effort** – one hand is enough
-  **Aesthetics** Uniform, **flush front design** with even gap pattern  
Allows constructions **with and without a handle** – the **technology remains invisible**

### Technical specifications

-  max. 25/35 kg
-  1200 – 2700 mm
-  440 – 750 mm
-  18 – 26 mm

### Good to know (accessories)

- Connector makes overlaid furniture structures possible
- Straightening fitting for doors

### Installation examples

Hawa Concepta III 25/35 Push

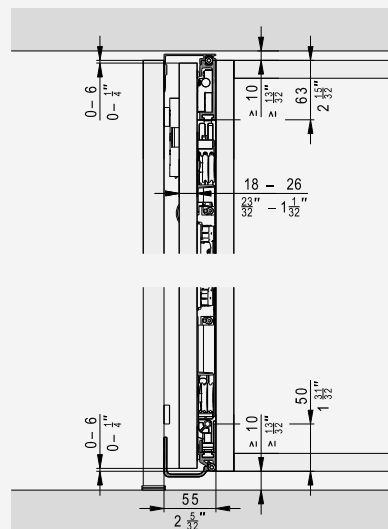

Hawa Concepta III 25/35 Pull

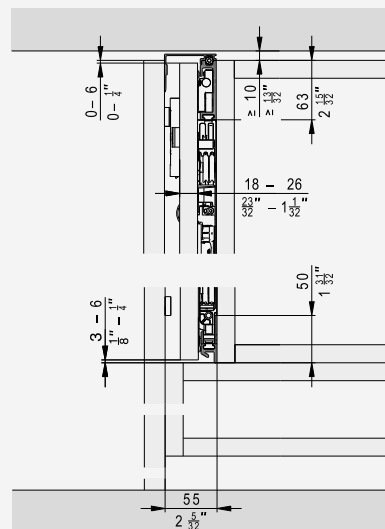

Hawa Concepta 25/35 Push

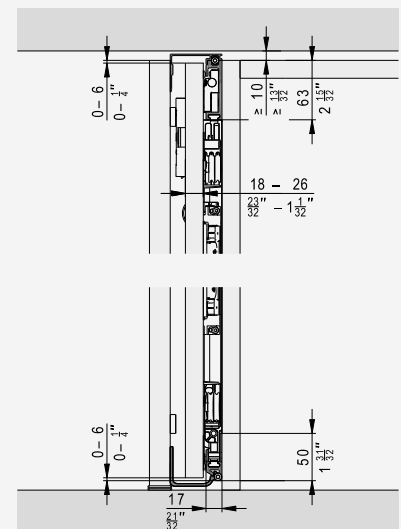

Door striking against the top and bottom cabinet sections

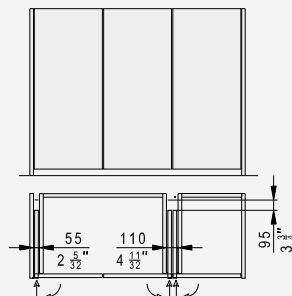

Composed cabinet overlay doors

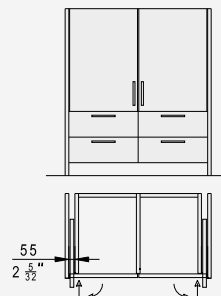

Overlay door without base

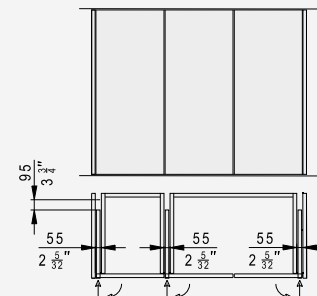



Components required for one cabinet

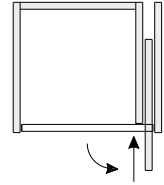
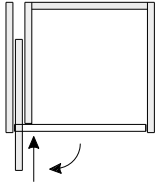

Hawa Concepta III 25 Push, left

	No.
Hawa Concepta III 25, basic set left, door height 1200–2200 mm (3' 11 1/4" to 7' 2 5/8")	30994
Hawa Concepta III 25/35, Push slide-in set, left	30998
Upright profile L= 1974 mm (6' 5 23/32"), for door height 1200–2200 mm (3' 11 1/4" to 7' 2 5/8"), aluminum, anodized	30778

Hawa Concepta III 25 Push, right

	No.
Hawa Concepta III 25, basic set right, door height 1200–2200 mm (3' 11 1/4" to 7' 2 5/8")	30995
Hawa Concepta III 25/35, Push slide-in set, right	30999
Upright profile L= 1974 mm (6' 5 23/32"), for door height 1200–2200 mm (3' 11 1/4" to 7' 2 5/8"), aluminum, anodized	30778

Weight and door size ratio calculations

The maximum weight must be adapted depending on the door size ratio.

DE Türbreite / FR Largeur de porte / EN Door width / IT Larghezza anta / ES Ancho de puerta

	440	500	550	600	650	700	750
2200	25	25	25	25	25	25	24
2150	25	25	25	25	25	25	23
2100	25	25	25	25	25	24	23
2050	25	25	25	25	25	24	22
2000	25	25	25	25	25	23	21
1950	25	25	25	25	24	22	21
1900	25	25	25	25	23	21	20
1850	25	25	25	24	22	21	19
1800	25	25	25	23	21	20	19
1750	25	25	25	22	21	19	18
1700	25	25	24	22	20	19	17
1650	25	25	23	21	19	18	17
1600	25	24	22	20	18	17	16
1550	25	23	21	19	18	16	15
1500	24	22	20	18	17	16	15
1450	23	21	19	17	16	15	14
1400	22	20	18	17	15	14	13
1350	21	19	17	16	15	14	13
1300	20	18	16	15	14	13	12
1250	19	17	15	14	13	12	11
1200	18	16	15	13	12	11	11

DE Maximale Gewichte in kg / FR Poids maximale en kg / EN Maximum weights in kg / IT Pesi massimo in kg / ES Pesos máximos en kg

DE Türhöhe / FR Hauteur de porte / EN Door height / IT Altezza anta / ES Altura de puerta

DE Türgewicht in kg / FR Poids de porte en kg / EN Door weight in kg / IT Peso anta in kg / ES Peso de puerta en kg

	1'5 <sup>5</sup> / <sub>16</sub> "	1'7 <sup>11</sup> / <sub>16</sub> "	1'9 <sup>21</sup> / <sub>32</sub> "	1'11 <sup>5</sup> / <sub>8</sub> "	2'1 <sup>19</sup> / <sub>32</sub> "	2'3 <sup>9</sup> / <sub>16</sub> "	2'5 <sup>17</sup> / <sub>32</sub> "
7'2 <sup>5</sup> / <sub>8</sub> "	55	55	55	55	55	55	53
7'0 <sup>21</sup> / <sub>32</sub> "	55	55	55	55	55	55	51
6'10 <sup>11</sup> / <sub>16</sub> "	55	55	55	55	55	53	51
6'8 <sup>23</sup> / <sub>32</sub> "	55	55	55	55	55	53	49
6'6 <sup>3</sup> / <sub>4</sub> "	55	55	55	55	55	51	46
6'4 <sup>25</sup> / <sub>32</sub> "	55	55	55	55	53	49	46
6'2 <sup>13</sup> / <sub>16</sub> "	55	55	55	55	51	46	44
6'0 <sup>27</sup> / <sub>32</sub> "	55	55	55	53	49	46	42
5'10 <sup>7</sup> / <sub>8</sub> "	55	55	55	51	46	44	42
5'8 <sup>29</sup> / <sub>32</sub> "	55	55	55	49	46	42	40
5'6 <sup>15</sup> / <sub>16</sub> "	55	55	53	49	44	42	37
5'4 <sup>31</sup> / <sub>32</sub> "	55	55	51	46	42	40	37
5'3"	55	53	49	44	40	37	35
5'1 <sup>1</sup> / <sub>32</sub> "	55	51	46	42	40	35	33
4'11 <sup>1</sup> / <sub>16</sub> "	53	49	44	40	37	35	33
4'9 <sup>3</sup> / <sub>32</sub> "	51	46	42	37	35	33	31
4'7 <sup>1</sup> / <sub>8</sub> "	49	44	40	37	33	31	29
4'5 <sup>5</sup> / <sub>32</sub> "	46	42	37	35	33	31	29
4'3 <sup>3</sup> / <sub>16</sub> "	44	40	35	33	31	29	26
4'1 <sup>7</sup> / <sub>32</sub> "	42	37	33	31	29	26	24
3'11 <sup>1</sup> / <sub>4</sub> "	40	35	33	29	26	24	24

DE Maximale Gewichte in lbs. / FR Poids maximale en lbs. / EN Maximum weights in lbs. / IT Pesi massimo in lbs. / ES Pesos máximos en lbs.

DE Türgewicht in lbs. / FR Poids de porte en lbs. / EN Door weight in lbs. / IT Peso anta in lbs. / ES Peso de puerta en lbs.

Hawa Configurator













[www.hawa.com/configurator](http://www.hawa.com/configurator)

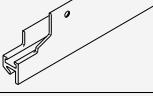

**List of individual parts, which are included in the sets:**



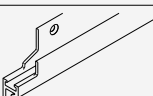



**Set for 1 pivot /slide-in door up to 25 kg (55 lbs.)**

	No.
Hawa Concepta III 25, basic set left, door height 1200–2200 mm (3' 11 1/4" to 7' 2 5/8")	30994
Hawa Concepta III 25, basic set right, door height 1200–2200 mm (3' 11 1/4" to 7' 2 5/8")	30995

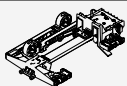

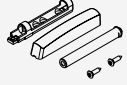
			No.	
	30994	30995		
<b>Set consisting of:</b>				
	Slot nuts for hinge attachment, plastic, black	3	3	30686
	Mounting plate for hinge with height adjustment, steel, nickel-plated	1	1	30738
	Concealed hinge, with soft closing mechanism and closing spring, steel, nickel plated	3	3	31070
	Set for concealed hinges, 8 screws 4x16 mm (5/32"x5/8"), 3 door stop buffers	1	1	30811
	Profile for magnetic guide, with double-sided adhesive tape, steel, black, L=730 mm (2' 4 3/4")	2	2	30983
	Euro screw, 6x13 mm (1/4"x1/2"), steel, black, set of 6 pieces	1	1	30986
	Bottom guide track left, aluminum, anodized, L= 838 mm (2' 9")	1		30805
	Top running track left, aluminum, anodized, L= 838 mm (2' 9")	1		31059
	Countersunk head screw, 4.5x20 mm (5/32"x25/32"), steel, zinc-plated, set of 16 pieces	1	1	30810
	Set of adjusting tools	1	1	31047
	Bottom guide track right, aluminum, anodized, L= 838 mm (2' 9")		1	30806
	Top running track right, aluminum, anodized, L= 838 mm (2' 9")		1	31060

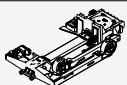
**Suitable slide-in set**

	No.
Hawa Concepta III 25/35, Push slide-in set, left	30998
Hawa Concepta III 25/35, Push slide-in set, right	30999

			No.	
	30998	30999		
<b>Set consisting of:</b>				
	Hawa Concepta III 25/35 Push slide-in unit, left	1		31038
	End stop bracket for push ejector, steel, zinc-plated	1	1	31043
	Push ejector, plastic, black	1	1	31010
	Push-to-open with adapter plate, plastic, black	1	1	30838
	Hawa Concepta III Push set of cover caps, for left-hand stop, plastic, black	1		30818
	Hawa Concepta III 25/35 Push slide-in unit, right		1	31039
	Hawa Concepta III Push set of cover caps, for right-hand stop, plastic, black		1	30827

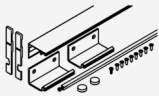
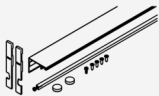
**Cabinet connecting parts**

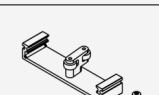
		mm (inch)	No.
	Connector set 55 mm (2 5/32"), for exterior connection to cabinet	560 (1' 10 1/16")	31005
	Connector top 55 mm (2 5/32"), for exterior connection to cabinet	560 (1' 10 1/16")	31430
	Connector top 110 mm (4 11/32"), for two pivot/slide-in doors	500 (1' 7 11/16")	31006
	Connector bottom 110 mm (4 11/32"), for two pivot/slide-in doors	500 (1' 7 11/16")	31246
	Connector bottom 110 mm (4 11/32"), for two pivot/slide-in doors (for installation in front of fixed plinth)	26 (1 1/32")	31007

**Guides**

	No.
	Guide for two inset pivot sliding doors, aluminum 25680

**Accessories**

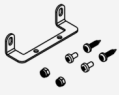
	No.
	Support for Halemeier automatic shut-off device Matching push button item 36 979 01 for Halemeier automatic shut-off device (Safety Box) 31020

**Straightening fitting**

→ Details under accessories from page 265

**Aluminum rew**

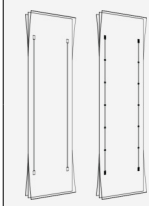
	No.
	Straightening fitting for doors 1715–2275 mm (3' 11 27/32" to 5' 9 7/8"), aluminum 056.3192.079
	Straightening fitting for doors 1215–1775 mm (3' 11 27/32" to 5' 9 7/8"), aluminum 056.3192.073

**Aluminum anodized**

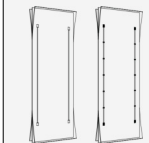
	Nr.
	Straightening fitting for doors 1715–2275 mm (5' 7 17/32" to 7' 5 9/16"), aluminum, anodized, can be shortened for doors 1215–1715 mm (3' 11 27/32" to 5' 7 17/32") 056.3192.080

**Aluminum black anodized**

	No.
	Straightening fitting for doors 1715–2275 mm (5' 7 15/32" to 7' 5 9/16"), aluminum, black anodized 056.3192.081
	Straightening fitting for doors 1215–1775 mm (3' 11 27/32" to 5' 9 7/8"), aluminum, black anodized 056.3192.076

**Straightening fitting**

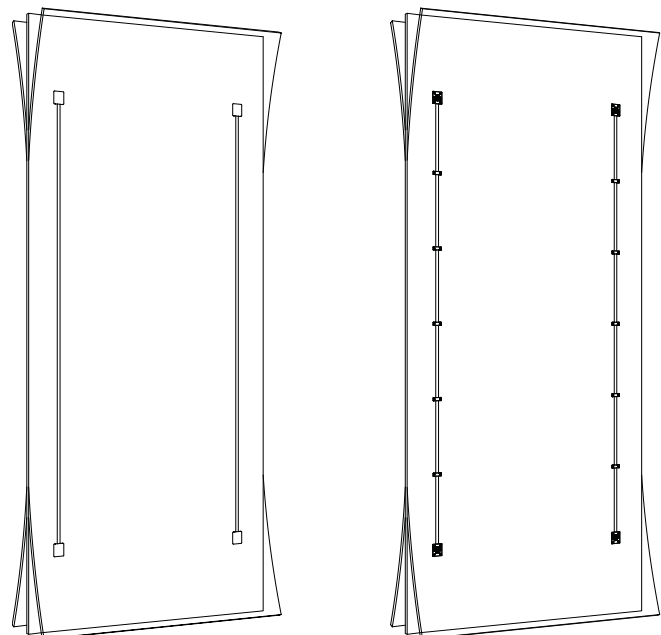



Inlaid doors

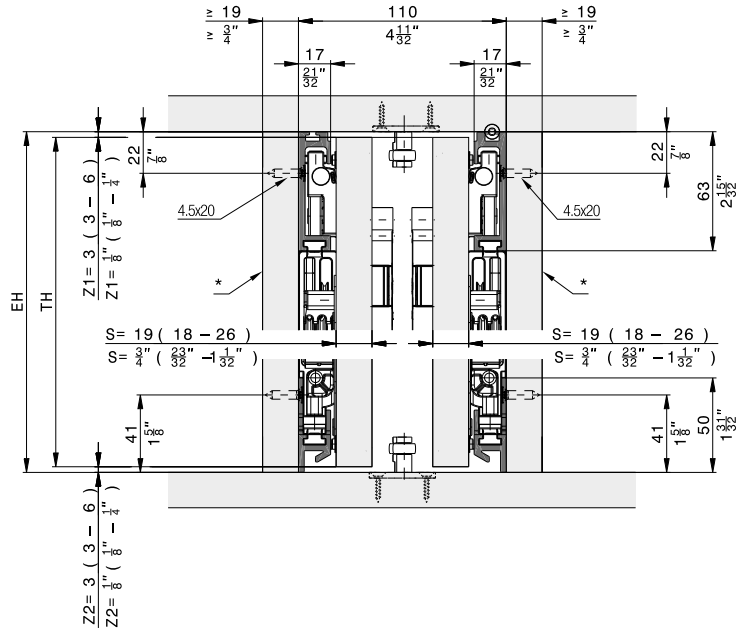
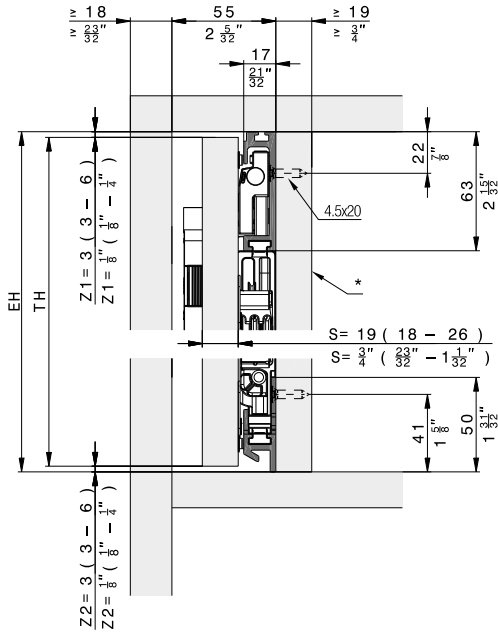

\* removable

Floor-to-ceiling doors

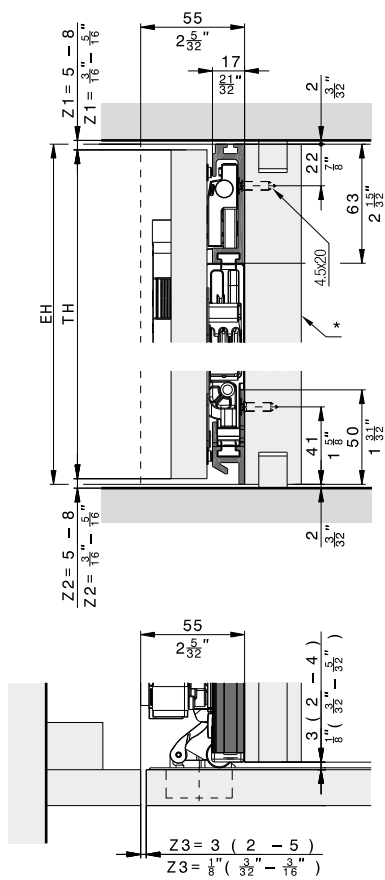

\* removable



Hardware depth calculation

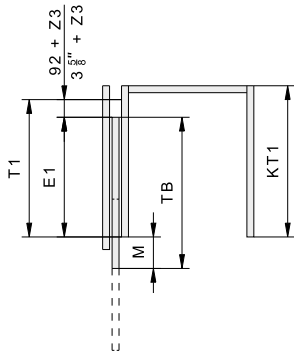

	mm	Inch
T1	≥ 414	≥ 1'4 <sup>5</sup> / <sub>16</sub> "

	mm	Inch
T1	TB + 92 + Z3 - M	TB + 3 <sup>5</sup> / <sub>8</sub> " + Z3 - M
E1	TB - M	TB - M
M	≥ S + 3 ≤ TB - 320	≥ S + <sup>5</sup> / <sub>8</sub> " ≤ TB - 1 <sup>19</sup> / <sub>32</sub> "

Door flush with outer face

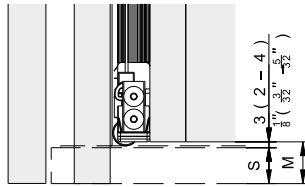

Protruding door

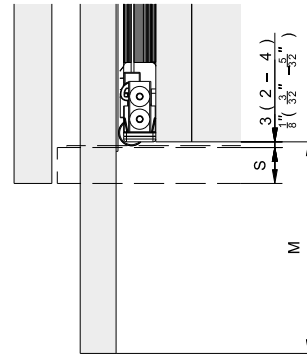

Instructions

- [Installation](#) →
- [Adjustment](#) →
- [Connector](#) →

Videos

- [Installation](#) →
- [Adjustment](#) →
- [Connector](#) →

Accessories

– Straightening fitting from page 265

Planning/execution

Configure with just a few clicks at [www.hawa.com/configurator](http://www.hawa.com/configurator)

Further information about the product can be found on [www.hawa.com](http://www.hawa.com).

Hardware for pivoting and lateral sliding in of wooden doors up to 25 kg (55 lbs.). Uniform, flush front design with even gap pattern. Pull version with handle and integrated soft closing mechanism.

Product highlights

- Productivity** Easy installation thanks to high degree of pre-assembly with intuitive adjustment
- Comfort** Ergonomic movement support for even, smooth movement
- Aesthetics** Allows constructions with and without handle – the technology remains invisible

Technical specifications

- 6–25 kg (13 to 55 lbs.)
- 1200–2200 mm (3' 11 1/4" to 7' 2 5/8")
- 440–750 mm (1' 5 5/16" to 2' 5 17/32")
- 18–26 mm (23/32" to 1 1/32")

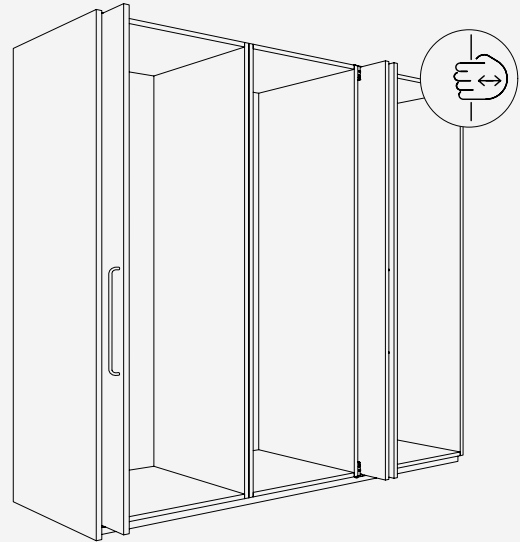

Installation examples

Door striking against the top and bottom cabinet sections

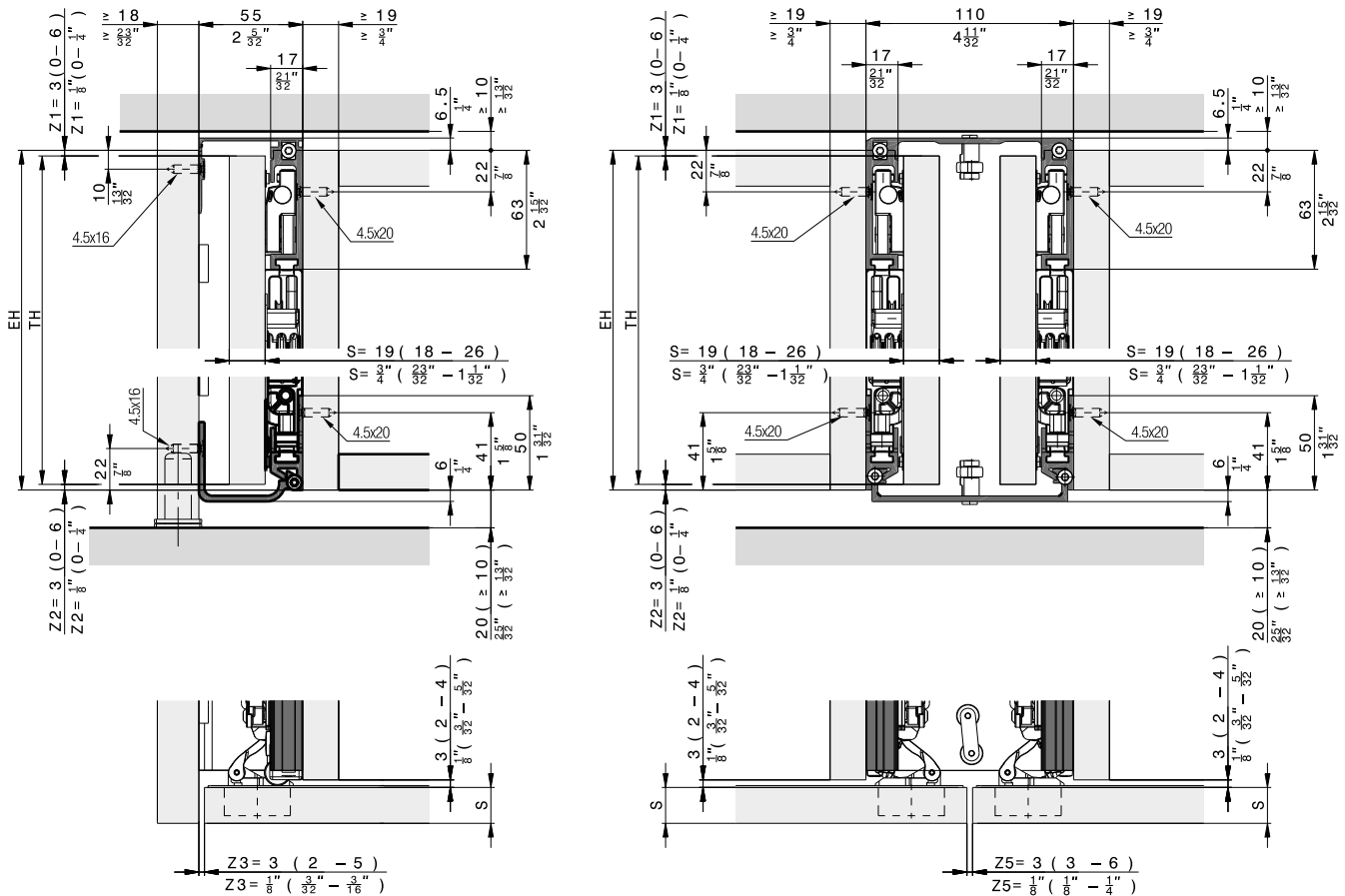

**Components required for one cabinet**

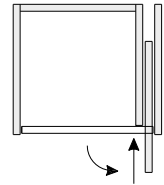
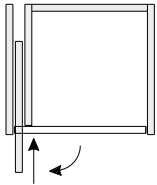

**Hawa Concepta III 25 Pull, left**

	No.
Hawa Concepta III 25, basic set left, door height 1200–2200 mm (3' 11 1/4" to 7' 2 5/8")	30994
Hawa Concepta III 25/35, Pull slide-in set, left	31000
Upright profile L= 1974 mm (6' 5 23/32"), for door height 1200–2200 mm (3' 11 1/4" to 7' 2 5/8"), aluminum, anodized	30778

**Hawa Concepta III 25 Pull, right**

	No.
Hawa Concepta III 25, basic set right, door height 1200–2200 mm (3' 11 1/4" to 7' 2 5/8")	30995
Hawa Concepta III 25/35, Pull slide-in set, right	31001
Upright profile L= 1974 mm (6' 5 23/32"), for door height 1200–2200 mm (3' 11 1/4" to 7' 2 5/8"), aluminum, anodized	30778

**Weight and door size ratio calculations**

The maximum weight must be adapted depending on the door size ratio.

DE Türbreite / FR Largeur de porte / EN Door width / IT Larghezza anta / ES Ancho de puerta

	440	500	550	600	650	700	750
2200	25	25	25	25	25	25	24
2150	25	25	25	25	25	25	23
2100	25	25	25	25	25	24	23
2050	25	25	25	25	25	24	22
2000	25	25	25	25	25	23	21
1950	25	25	25	25	24	22	21
1900	25	25	25	25	23	21	20
1850	25	25	25	24	22	21	19
1800	25	25	25	23	21	20	19
1750	25	25	25	22	21	19	18
1700	25	25	24	22	20	19	17
1650	25	25	23	21	19	18	17
1600	25	24	22	20	18	17	16
1550	25	23	21	19	18	16	15
1500	24	22	20	18	17	16	15
1450	23	21	19	17	16	15	14
1400	22	20	18	17	15	14	13
1350	21	19	17	16	15	14	13
1300	20	18	16	15	14	13	12
1250	19	17	15	14	13	12	11
1200	18	16	15	13	12	11	11

DE Maximale Gewichte in kg / FR Poids maximale en kg / EN Maximum weights in kg / IT Pesi massimo in kg / ES Pesos máximos en kg

	1'5 5/16"	1'7 11/16"	1'9 21/32"	1'11 3/8"	2'1 19/32"	2'3 9/16"	2'5 17/32"
7'2 5/8"	55	55	55	55	55	55	53
7'0 21/32"	55	55	55	55	55	55	51
6'10 11/16"	55	55	55	55	55	53	51
6'8 23/32"	55	55	55	55	55	53	49
6'6 3/4"	55	55	55	55	55	51	46
6'4 25/32"	55	55	55	55	53	49	46
6'2 13/16"	55	55	55	55	51	46	44
6'0 27/32"	55	55	55	53	49	46	42
5'10 7/8"	55	55	55	51	46	44	42
5'8 29/32"	55	55	55	49	46	42	40
5'6 15/16"	55	55	53	49	44	42	37
5'4 31/32"	55	55	51	46	42	40	37
5'3"	55	53	49	44	40	37	35
5'1 1/32"	55	51	46	42	40	35	33
4'11 1/16"	53	49	44	40	37	35	33
4'9 3/32"	51	46	42	37	35	33	31
4'7 1/8"	49	44	40	37	33	31	29
4'5 5/32"	46	42	37	35	33	31	29
4'3 3/16"	44	40	35	33	31	29	26
4'1 7/32"	42	37	33	31	29	26	24
3'11 1/4"	40	35	33	29	26	24	24

DE Maximale Gewichte in lbs. / FR Poids maximale en lbs. / EN Maximum weights in lbs. / IT Pesi massimo in lbs. / ES Pesos máximos en lbs.

DE Türgewicht in kg / FR Poids de porte en kg / EN Door weight in kg / IT Peso anta in kg / ES Peso de puerta en kg

DE Türgewicht in lbs. / FR Poids de porte en lbs. / EN Door weight in lbs. / IT Peso anta in lbs. / ES Peso de puerta en lbs.

**Hawa Configurator**













[www.hawa.com/configurator](http://www.hawa.com/configurator)

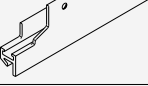

List of individual parts, which are included in the sets:







Set for 1 pivot /slide-in door up to 25 kg (55 lbs.)

	No.
Hawa Concepta III 25, basic set left, door height 1200–2200 mm (3' 11 1/4" to 7' 2 5/8")	30994
Hawa Concepta III 25, basic set right, door height 1200–2200 mm (3' 11 1/4" to 7' 2 5/8")	30995

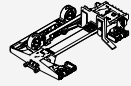

	No.			No.
		30994	30995	
<b>Set consisting of:</b>				
	Slot nuts for hinge attachment, plastic, black	3	3	30686
	Mounting plate for hinge with height adjustment, steel, nickel-plated	1	1	30738
	Concealed hinge, with soft closing mechanism and closing spring, steel, nickel plated	3	3	31070
	Set for concealed hinges, 8 screws 4x16 mm (5/32"x5/8"), 3 door stop buffers	1	1	30811
	Profile for magnetic guide, with double-sided adhesive tape, steel, black, L=730 mm (2' 4 3/4")	2	2	30983
	Euro screw, 6x13 mm (1/4"x1/2"), steel, black, set of 6 pieces	1	1	30986
	Bottom guide track left, aluminum, anodized, L= 838 mm (2' 9")	1		30805
	Top running track left, aluminum, anodized, L= 838 mm (2' 9")	1		31059
	Countersunk head screw, 4.5x20 mm (5/32"x25/32"), steel, zinc-plated, set of 16 pieces	1	1	30810
	Set of adjusting tools	1	1	31047
	Bottom guide track right, aluminum, anodized, L= 838 mm (2' 9")		1	30806
	Top running track right, aluminum, anodized, L= 838 mm (2' 9")		1	31060

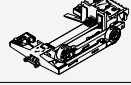
Suitable slide-in set

	No.
Hawa Concepta III 25/35, Pull slide-in set, left	31000
Hawa Concepta III 25/35, Pull slide-in set, right	31001

	No.			No.
		31000	31001	
<b>Set consisting of:</b>				
	Hawa Concepta III 25/35 Pull slide-in unit, left	1		31040
	End stop bracket Pull, steel zinc-plated	1	1	31414
	Soft closing mechanism with end stop	1	1	31221
	Hawa Concepta III Pull set of cover caps, for left-hand stop, plastic, black	1		30964
	Hawa Concepta III 25/35 Pull slide-in unit, right		1	31041
	Hawa Concepta III Pull set of cover caps, for right-hand stop, plastic, black		1	30965

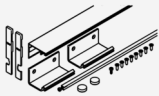
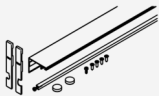
**Cabinet connecting parts**

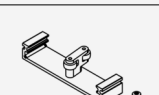
		mm (inch)	No.
	Connector set 55 mm (2 5/32"), for exterior connection to cabinet	560 (1' 10 1/16")	31005
	Connector top 55 mm (2 5/32"), for exterior connection to cabinet	560 (1' 10 1/16")	31430
	Connector top 110 mm (4 11/32"), for two pivot/slide-in doors	500 (1' 7 11/16")	31006
	Connector bottom 110 mm (4 11/32"), for two pivot/slide-in doors	500 (1' 7 11/16")	31246
	Connector bottom 110 mm (4 11/32"), for two pivot/slide-in doors (for installation in front of fixed plinth)	26 (1 1/32")	31007

**Guides**

	No.
	25680

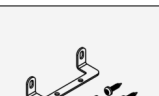

**Accessories**

	No.
	31020

**Straightening fitting**

→ Details under accessories from page 265



**Aluminum rew**

	No.
	056.3192.079
	056.3192.073

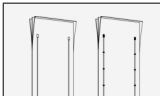
**Aluminum anodized**

	Nr.
	056.3192.080

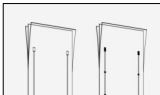
**Aluminum black anodized**

	No.
	056.3192.081
	056.3192.076

**Straightening fitting**

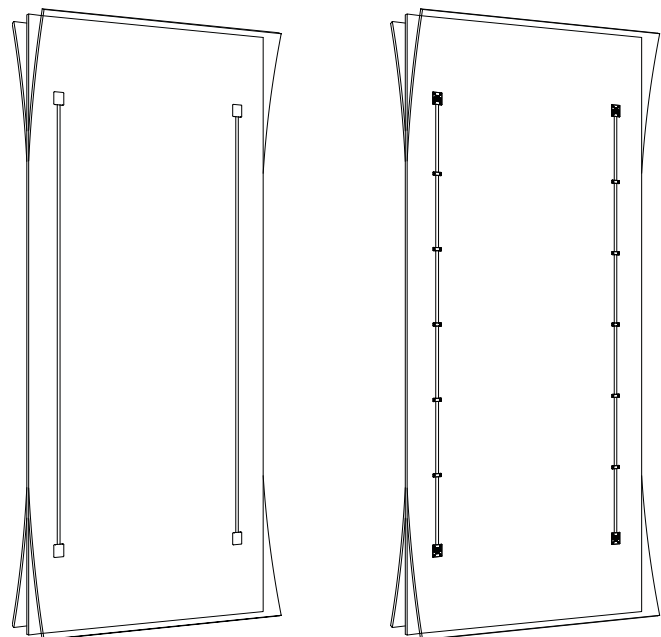

Further installation examples  
Composed cabinet

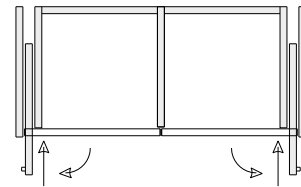
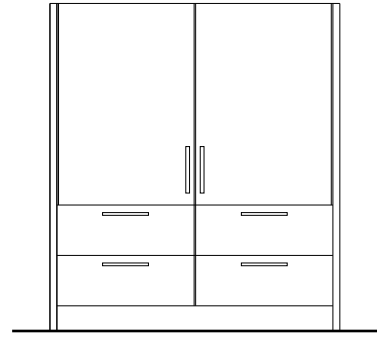
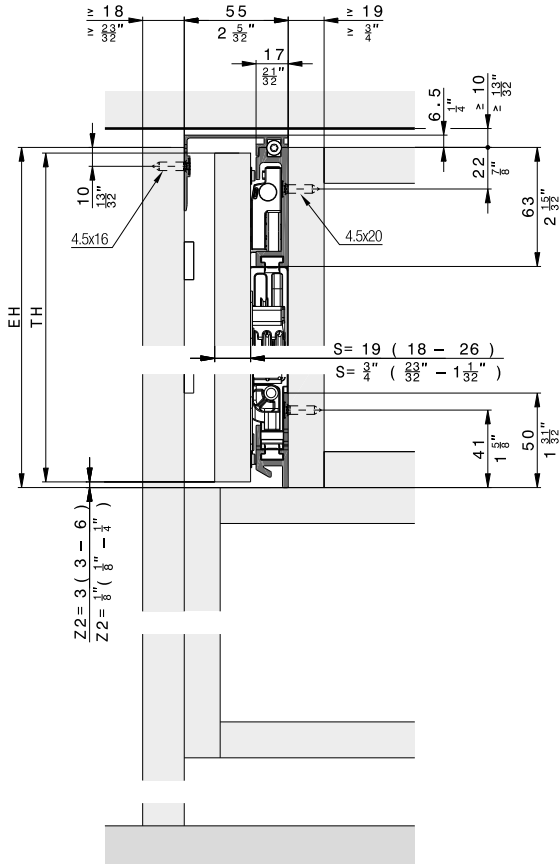

Cabinet without base panel

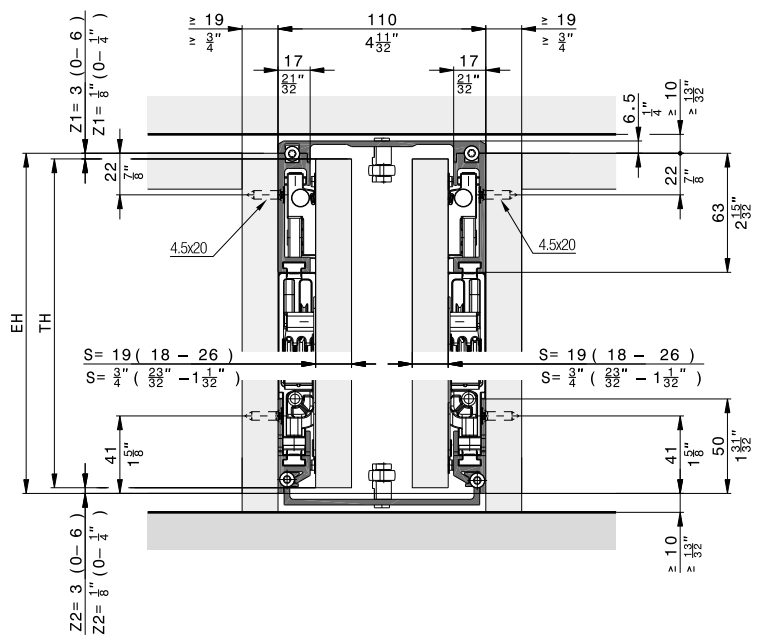
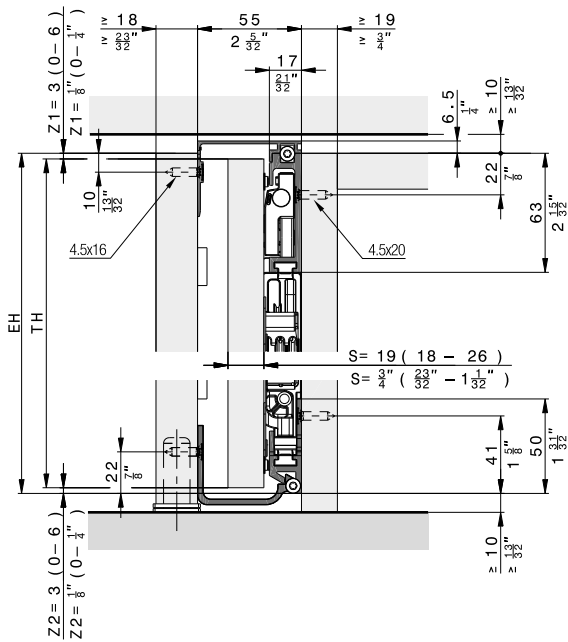

Inlaid doors

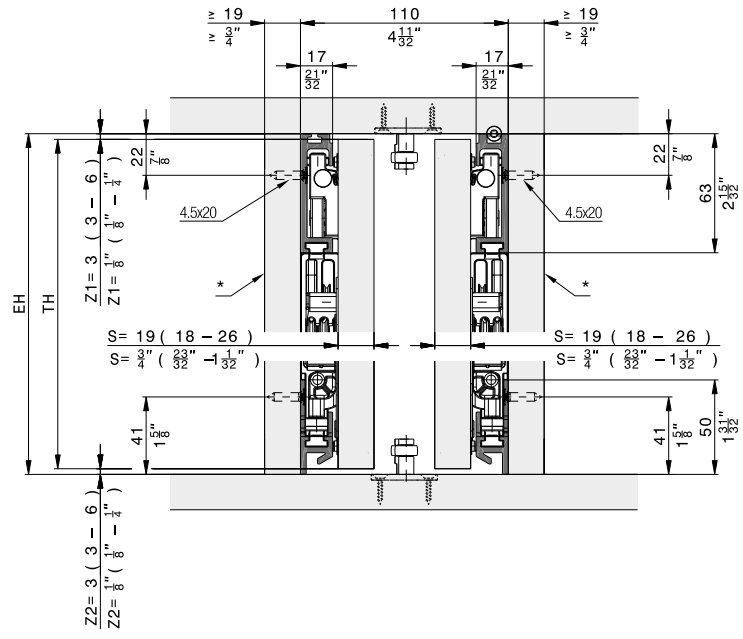
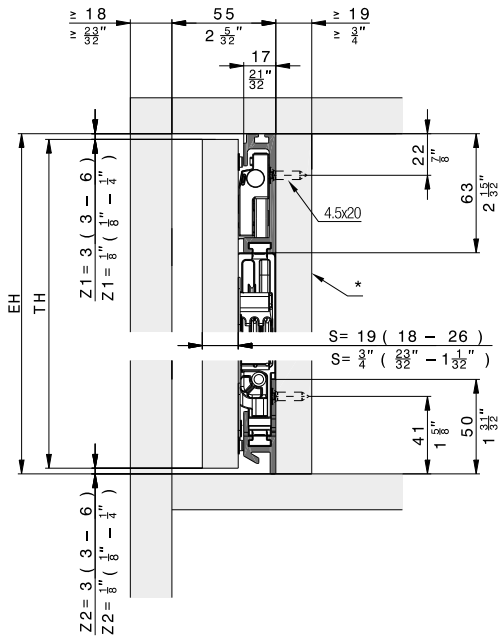

\* removable

Floor-to-ceiling doors

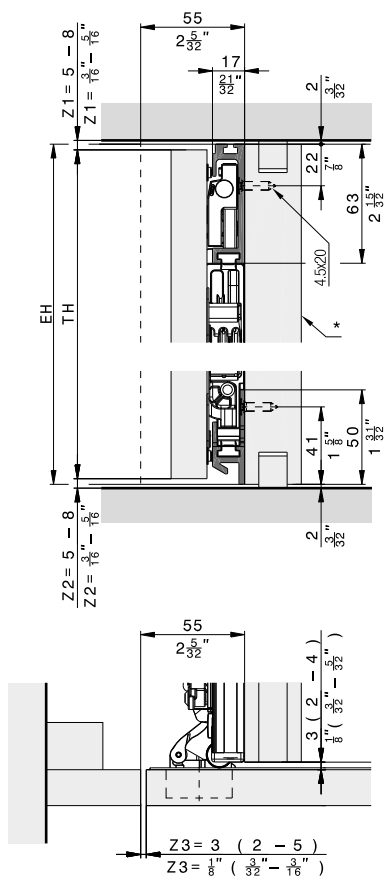

\* removable

Hardware depth calculation

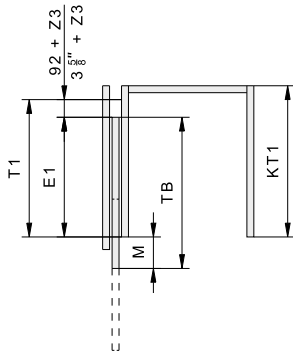

	mm	Inch
T1	≥ 414	≥ 1'4 <sup>5</sup> / <sub>16</sub> "

	mm	Inch
T1	TB + 92 + Z3 - M	TB + 3 <sup>5</sup> / <sub>8</sub> " + Z3 - M
E1	TB - M	TB - M
M	≥ S + 3 ≤ TB - 320	≥ S + <sup>5</sup> / <sub>8</sub> " ≤ TB - 1 <sup>19</sup> / <sub>32</sub> "

Door flush with outer face

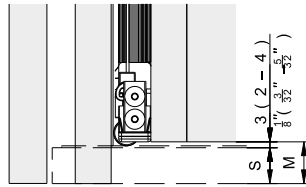

Protruding door

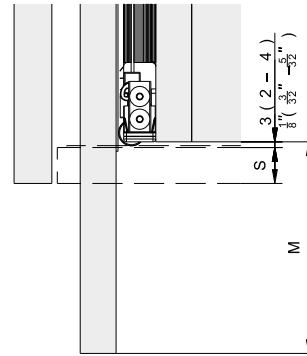

Instructions

- [Installation](#) →
- [Adjustment](#) →
- [Connector](#) →

Videos

- [Installation](#) →
- [Adjustment](#) →
- [Connector](#) →

Accessories

– Straightening fitting from page 265

Planning/execution

Configure with just a few clicks at [www.hawa.com/configurator](http://www.hawa.com/configurator)

Further information about the product can be found on [www.hawa.com](http://www.hawa.com).





Components required for one cabinet

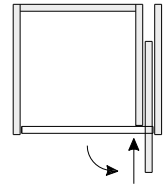
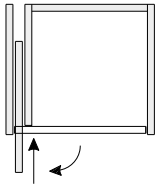

Hawa Concepta III 35 Push, left

	No.
Hawa Concepta III 35, basic set left, door height 1900–2700 mm (6' 2 13/16" to 8' 10 5/16")	30996
Hawa Concepta III 25/35, Push slide-in set, left	30998
Upright profile L= 2474 mm (8' 1 13/32"), for door height 1900–2700 mm (6' 2 13/16" to 8' 10 5/16"), aluminum, anodized	30771

Hawa Concepta III 35 Push, right

	No.
Hawa Concepta III 35, basic set right, door height 1900–2700 mm (6' 2 13/16" to 8' 10 5/16")	30997
Hawa Concepta III 25/35, Push slide-in set, right	30999
Upright profile L= 2474 mm (8' 1 13/32"), for door height 1900–2700 mm (6' 2 13/16" to 8' 10 5/16"), aluminum, anodized	30771

Weight and door size ratio calculations

The maximum weight must be adapted depending on the door size ratio.

DE Türbreite / FR Largeur de porte / EN Door width / IT Larghezza anta / ES Ancho de puerta

DE Türhöhe / FR Hauteur de porte / EN Door height / IT Altezza anta / ES Altura de puerta	DE Türbreite / FR Largeur de porte / EN Door width / IT Larghezza anta / ES Ancho de puerta						
	440	500	550	600	650	700	750
2700	35	35	35	35	35	35	35
2650	35	35	35	35	35	35	35
2600	35	35	35	35	35	35	35
2550	35	35	35	35	35	35	35
2500	35	35	35	35	35	35	35
2450	35	35	35	35	35	35	34
2400	35	35	35	35	35	35	33
2350	35	35	35	35	35	34	32
2300	35	35	35	35	35	34	31
2250	35	35	35	35	35	33	31
2200	35	35	35	35	34	32	30
2150	35	35	35	35	33	31	29
2100	35	35	35	35	32	30	28
2050	35	35	35	34	31	29	27
2000	35	35	35	33	30	28	26
1950	35	35	35	32	29	27	26
1900	35	35	34	31	29	27	25

DE Türgewicht in kg / FR Poids de porte en kg / EN Door weight in kg / IT Peso anta in kg / ES Peso de puerta en kg

DE Türhöhe / FR Hauteur de porte / EN Door height / IT Altezza anta / ES Altura de puerta	DE Türbreite / FR Largeur de porte / EN Door width / IT Larghezza anta / ES Ancho de puerta									
	1' 5 5/16"	1' 7 11/16"	1' 9 21/32"	1' 11 5/8"	2' 1 19/32"	2' 3 9/16"	2' 5 17/32"			
8' 10 5/16"	77	77	77	77	77	77	77			
8' 8 11/32"	77	77	77	77	77	77	77			
8' 6 3/8"	77	77	77	77	77	77	77			
8' 4 13/32"	77	77	77	77	77	77	77			
8' 2 7/16"	77	77	77	77	77	77	77			
8' 0 15/32"	77	77	77	77	77	77	77	75		
7' 10 1/2"	77	77	77	77	77	77	77	73		
7' 8 17/32"	77	77	77	77	77	77	75	71		
7' 6 9/16"	77	77	77	77	77	77	75	68		
7' 4 19/32"	77	77	77	77	77	77	73	68		
7' 2 5/8"	77	77	77	77	77	75	71	66		
7' 0 21/32"	77	77	77	77	77	73	68	64		
6' 10 11/16"	77	77	77	77	77	71	66	62		
6' 8 23/32"	77	77	77	77	75	68	64	60		
6' 6 3/4"	77	77	77	77	73	66	62	57		
6' 4 25/32"	77	77	77	77	71	64	60	57		
6' 2 13/16"	77	77	75	68	64	60	55			

DE Türgewicht in lbs. / FR Poids de porte en lbs. / EN Door weight in lbs. / IT Peso anta in lbs. / ES Peso de puerta en lbs.

DE Maximale Gewichte in kg / FR Poids maximale en kg / EN Maximum weights in kg / IT Pesi massimo in kg / ES Pesos máximos en kg

DE Maximale Gewichte in lbs. / FR Poids maximale en lbs. / EN Maximum weights in lbs. / IT Pesi massimo in lbs. / ES Pesos máximos en lbs.

Hawa Configurator













[www.hawa.com/configurator](http://www.hawa.com/configurator)

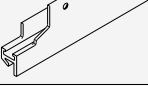

**List of individual parts, which are included in the sets:**







**Set for 1 pivot /slide-in door up to 35 kg (77 lbs.)**

	No.
Hawa Concepta III 35, basic set left, door height 1900–2700 mm (6' 2 13/16" to 8' 10 5/16")	30996
Hawa Concepta III 35, basic set right, door height 1900–2700 mm (6' 2 13/16" to 8' 10 5/16")	30997

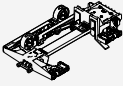

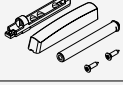
	30996	30997	No.
<b>Set consisting of:</b>			
 Slot nuts for hinge attachment, plastic, black	4	4	30686
 Mounting plate for hinge with height adjustment, steel, nickel-plated	1	1	30738
 Concealed hinge, with soft closing mechanism and closing spring, steel, nickel plated	4	4	31070
 Set for concealed hinges, 8 screws 4x16 mm (5/32"x5/8"), 3 door stop buffers	1	1	30811
 Profile for magnetic guide, with double-sided adhesive tape, steel, black, L=730 mm (2' 4 3/4")	2	2	30983
 Euro screw, 6x13 mm (1/4"x1/2"), steel, black, set of 6 pieces	1	1	30986
 Bottom guide track left, aluminum, anodized, L= 838 mm (2' 9")	1		30805
 Top running track left, aluminum, anodized, L= 838 mm (2' 9")	1		31059
 Countersunk head screw, 4.5x20 mm (5/32"x25/32"), steel, zinc-plated, set of 16 pieces	1	1	30810
 Set of adjusting tools	1	1	31047
 Bottom guide track right, aluminum, anodized, L= 838 mm (2' 9")		1	30806
 Top running track right, aluminum, anodized, L= 838 mm (2' 9")		1	31060

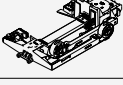
**Suitable slide-in set**

	No.
Hawa Concepta III 25/35, Push slide-in set, left	30998
Hawa Concepta III 25/35, Push slide-in set, right	30999

	30998	30999	No.
<b>Set consisting of:</b>			
 Hawa Concepta III 25/35 Push slide-in unit, left	1		31038
 End stop bracket for push ejector, steel, zinc-plated	1	1	31043
 Push ejector, plastic, black	1	1	31010
 Push-to-open with adapter plate, plastic, black	1	1	30838
 Hawa Concepta III Push set of cover caps, for left-hand stop, plastic, black	1		30818
 Hawa Concepta III 25/35 Push slide-in unit, right		1	31039
 Hawa Concepta III Push set of cover caps, for right-hand stop, plastic, black		1	30827

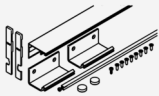
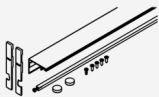
**Cabinet connecting parts**

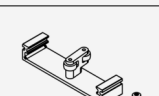
		mm (inch)	No.
	Connector set 55 mm (2 5/32"), for exterior connection to cabinet	560 (1' 10 1/16")	31005
	Connector top 55 mm (2 5/32"), for exterior connection to cabinet	560 (1' 10 1/16")	31430
	Connector top 110 mm (4 11/32"), for two pivot/slide-in doors	500 (1' 7 11/16")	31006
	Connector bottom 110 mm (4 11/32"), for two pivot/slide-in doors	500 (1' 7 11/16")	31246
	Connector bottom 110 mm (4 11/32"), for two pivot/slide-in doors (for installation in front of fixed plinth)	26 (1 1/32")	31007

**Guides**

	No.
	25680

**Accessories**

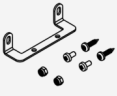
	No.
	31020

**Straightening fitting**

→ Details under accessories from page 265

**Aluminum rew**

	Nr.
	056.3192.072
	056.3192.079

**Aluminum anodized**

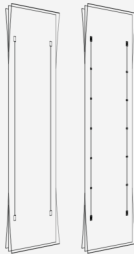
	No.
	056.3192.071
	056.3192.082
	056.3192.080

**Aluminum black anodized**

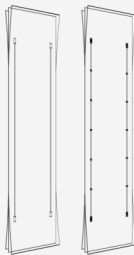
	No.
	056.3192.074
	056.3192.075
	056.3192.081

**Straightening fitting**

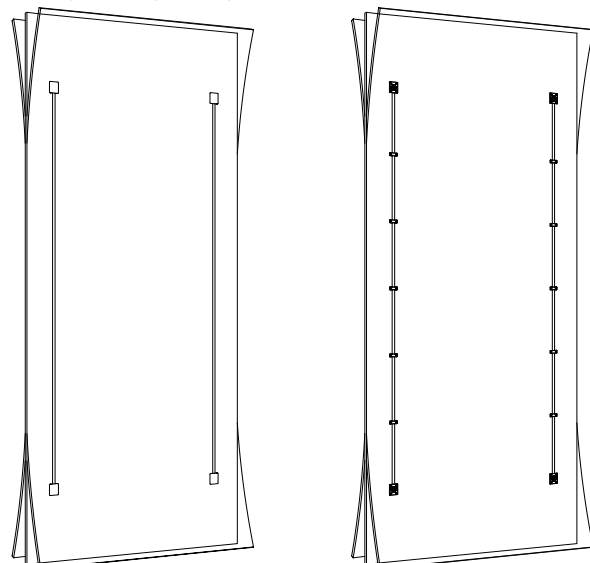

Further installation examples

Composed cabinet

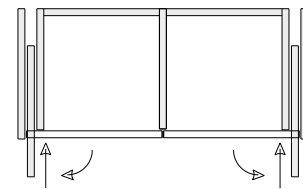
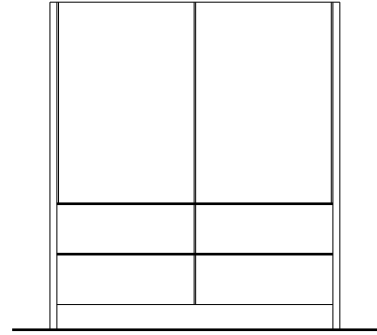
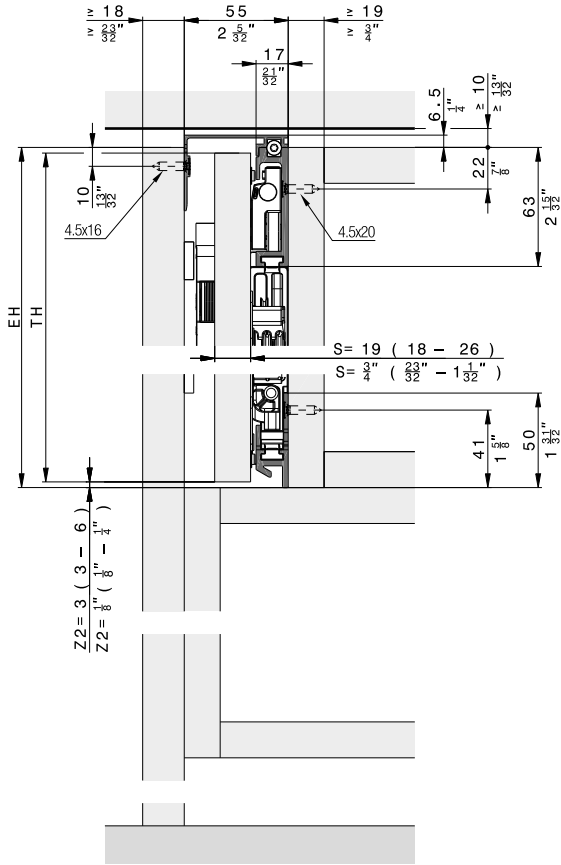

Cabinet without base panel

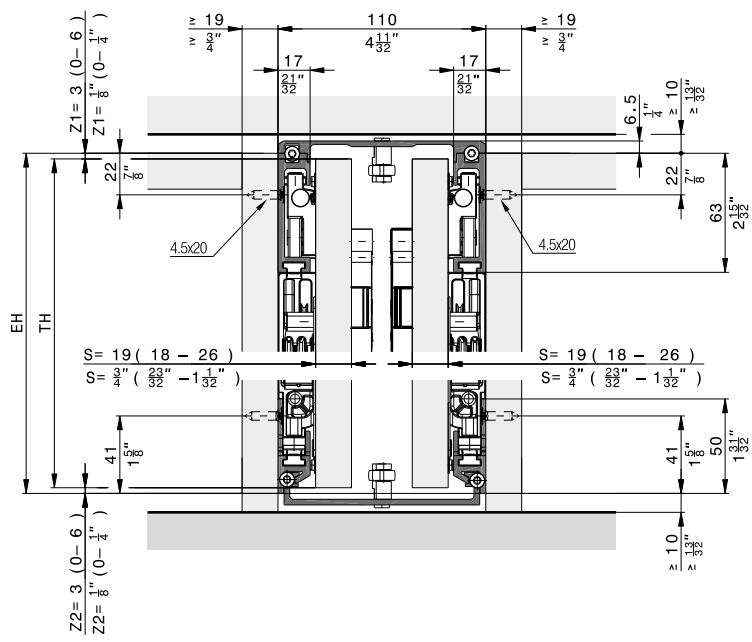
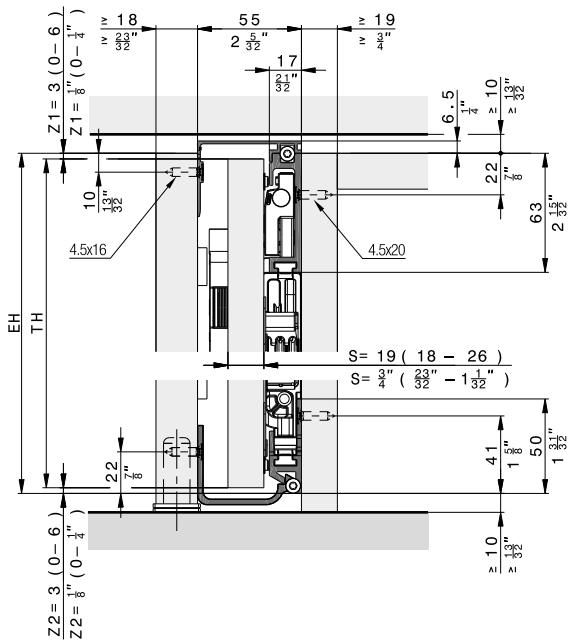

Inlaid doors

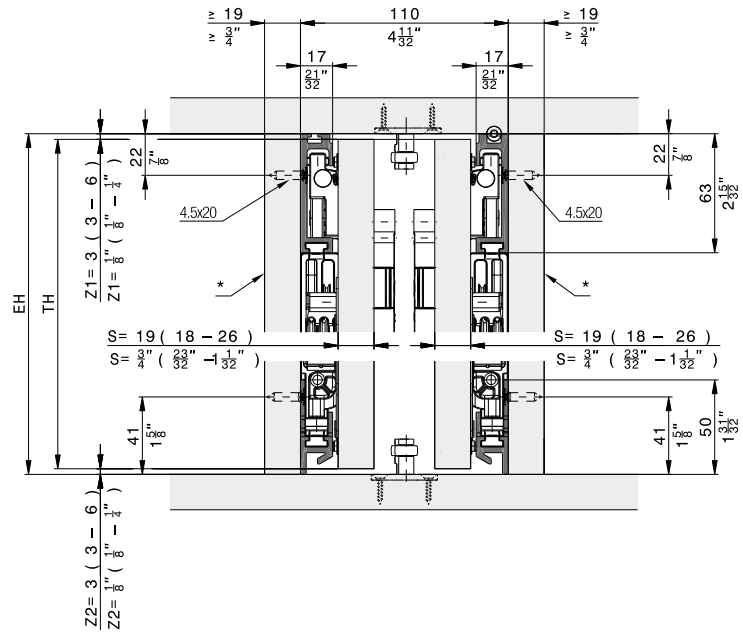
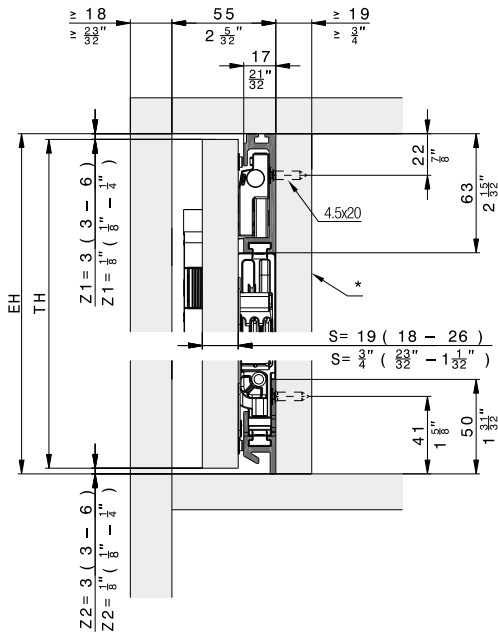

\* removable

Floor-to-ceiling doors

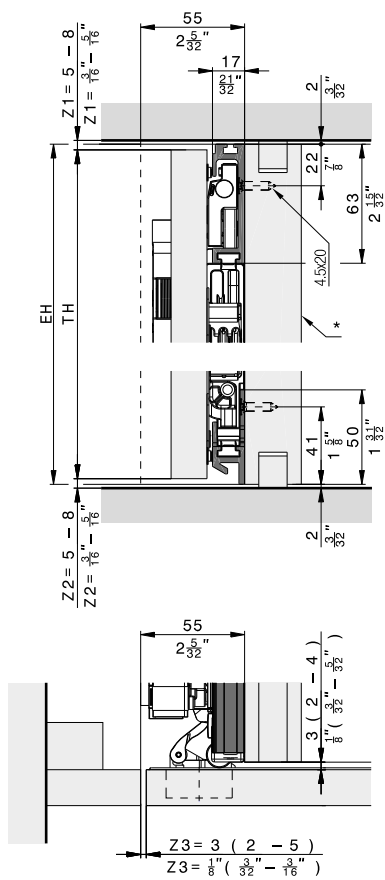

\* removable

Hardware depth calculation

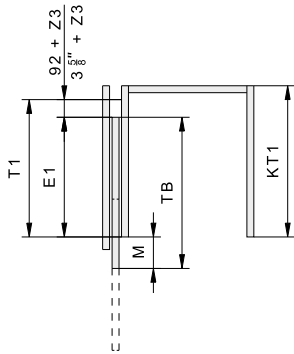

	mm	Inch
T1	≥ 414	≥ 1'4 <sup>5</sup> / <sub>16</sub> "

	mm	Inch
T1	TB + 92 + Z3 - M	TB + 3 <sup>5</sup> / <sub>8</sub> " + Z3 - M
E1	TB - M	TB - M
M	≥ S + 3 ≤ TB - 320	≥ S + <sup>5</sup> / <sub>8</sub> " ≤ TB - 1 <sup>19</sup> / <sub>32</sub> "

Door flush with outer face

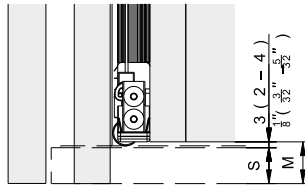

Protruding door

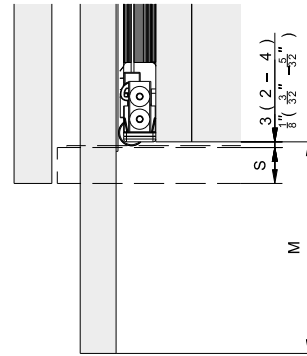

Instructions

- [Installation](#) →
- [Adjustment](#) →
- [Connector](#) →

Videos

- [Installation](#) →
- [Adjustment](#) →
- [Connector](#) →

Accessories

– Straightening fitting from page 265

Planning/execution

Configure with just a few clicks at [www.hawa.com/configurator](http://www.hawa.com/configurator)

Further information about the product can be found on [www.hawa.com](http://www.hawa.com).





**Components required for one cabinet**

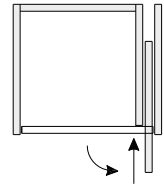
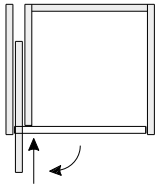

**Hawa Concepta III 35 Pull, left**

	No.
Hawa Concepta III 35, basic set left, door height 1900–2700 mm (6' 2 13/16" to 8' 10 5/16")	30996
Hawa Concepta III 25/35, Pull slide-in set, left	31000
Upright profile L= 2474 mm (8' 1 13/32"), for door height 1900–2700 mm (6' 2 13/16" to 8' 10 5/16"), aluminum, anodized	30771

**Hawa Concepta III 35 Pull, right**

	No.
Hawa Concepta III 35, basic set right, door height 1900–2700 mm (6' 2 13/16" to 8' 10 5/16")	30997
Hawa Concepta III 25/35, Pull slide-in set, right	31001
Upright profile L= 2474 mm (8' 1 13/32"), for door height 1900–2700 mm (6' 2 13/16" to 8' 10 5/16"), aluminum, anodized	30771

**Weight and door size ratio calculations**

The maximum weight must be adapted depending on the door size ratio.

DE Türbreite / FR Largeur de porte / EN Door width / IT Larghezza anta / ES Ancho de puerta

	440	500	550	600	650	700	750
2700	35	35	35	35	35	35	35
2650	35	35	35	35	35	35	35
2600	35	35	35	35	35	35	35
2550	35	35	35	35	35	35	35
2500	35	35	35	35	35	35	35
2450	35	35	35	35	35	35	34
2400	35	35	35	35	35	35	33
2350	35	35	35	35	35	34	32
2300	35	35	35	35	35	34	31
2250	35	35	35	35	35	33	31
2200	35	35	35	35	34	32	30
2150	35	35	35	35	33	31	29
2100	35	35	35	35	32	30	28
2050	35	35	35	34	31	29	27
2000	35	35	35	33	30	28	26
1950	35	35	35	32	29	27	26
1900	35	35	34	31	29	27	25

DE Türgewicht in kg / FR Poids de porte en kg / EN Door weight in kg / IT Peso anta in kg / ES Peso de puerta en kg

	1' 5 5/16"	1' 7 11/16"	1' 9 21/32"	1' 11 5/8"	2' 1 19/32"	2' 3 9/16"	2' 5 17/32"
8' 10 5/16"	77	77	77	77	77	77	77
8' 8 11/32"	77	77	77	77	77	77	77
8' 6 3/8"	77	77	77	77	77	77	77
8' 4 13/32"	77	77	77	77	77	77	77
8' 2 7/16"	77	77	77	77	77	77	77
8' 0 15/32"	77	77	77	77	77	77	75
7' 10 1/2"	77	77	77	77	77	77	73
7' 8 17/32"	77	77	77	77	77	75	71
7' 6 9/16"	77	77	77	77	77	75	68
7' 4 19/32"	77	77	77	77	77	73	68
7' 2 5/8"	77	77	77	77	75	71	66
7' 0 21/32"	77	77	77	77	73	68	64
6' 10 11/16"	77	77	77	77	71	66	62
6' 8 23/32"	77	77	77	75	68	64	60
6' 6 3/4"	77	77	77	73	66	62	57
6' 4 25/32"	77	77	77	71	64	60	57
6' 2 13/16"	77	77	75	68	64	60	55

DE Türgewicht in lbs. / FR Poids de porte en lbs. / EN Door weight in lbs. / IT Peso anta in lbs. / ES Peso de puerta en lbs.

DE Türhöhe / FR Hauteur de porte / EN Door height / IT Altezza anta / ES Altura de puerta

DE Maximale Gewichte in kg / FR Poids maximale en kg / EN Maximum weights in kg / IT Pesi massimo in kg / ES Pesos máximos en kg

DE Maximale Gewichte in lbs. / FR Poids maximale en lbs. / EN Maximum weights in lbs. / IT Pesi massimo in lbs. / ES Pesos máximos en lbs.













**Hawa Configurator**

[www.hawa.com/configurator](http://www.hawa.com/configurator) →

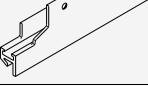
List of individual parts, which are included in the sets:







Set for 1 pivot /slide-in door up to 35 kg (77 lbs.)

	No.
Hawa Concepta III 35, basic set left, door height 1900–2700 mm (6' 2 13/16" to 8' 10 5/16")	30996
Hawa Concepta III 35, basic set right, door height 1900–2700 mm (6' 2 13/16" to 8' 10 5/16")	30997

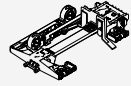

		30996	30997	No.
<b>Set consisting of:</b>				
	Slot nuts for hinge attachment, plastic, black	4	4	30686
	Mounting plate for hinge with height adjustment, steel, nickel-plated	1	1	30738
	Concealed hinge, with soft closing mechanism and closing spring, steel, nickel plated	4	4	31070
	Set for concealed hinges, 8 screws 4x16 mm (5/32"x5/8"), 3 door stop buffers	1	1	30811
	Profile for magnetic guide, with double-sided adhesive tape, steel, black, L=730 mm (2' 4 3/4")	2	2	30983
	Euro screw, 6x13 mm (1/4"x1/2"), steel, black, set of 6 pieces	1	1	30986
	Bottom guide track left, aluminum, anodized, L= 838 mm (2' 9")	1		30805
	Top running track left, aluminum, anodized, L= 838 mm (2' 9")	1		31059
	Countersunk head screw, 4.5x20 mm (5/32"x25/32"), steel, zinc-plated, set of 16 pieces	1	1	30810
	Set of adjusting tools	1	1	31047
	Bottom guide track right, aluminum, anodized, L= 838 mm (2' 9")		1	30806
	Top running track right, aluminum, anodized, L= 838 mm (2' 9")		1	31060

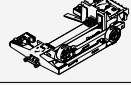
Suitable slide-in set

	No.
Hawa Concepta III 25/35, Pull slide-in set, left	31000
Hawa Concepta III 25/35, Pull slide-in set, right	31001

		31000	31001	No.
<b>Set consisting of:</b>				
	Hawa Concepta III 25/35 Pull slide-in unit, left	1		31040
	End stop bracket Pull, steel zinc-plated	1	1	31414
	Soft closing mechanism with end stop	1	1	31221
	Hawa Concepta III Pull set of cover caps, for left-hand stop, plastic, black	1		30964
	Hawa Concepta III 25/35 Pull slide-in unit, right		1	31041
	Hawa Concepta III Pull set of cover caps, for right-hand stop, plastic, black		1	30965

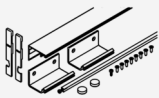
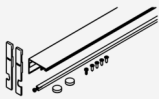
**Cabinet connecting parts**

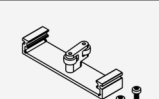
		mm (inch)	No.
	Connector set 55 mm (2 5/32"), for exterior connection to cabinet	560 (1' 10 1/16")	31005
	Connector top 55 mm (2 5/32"), for exterior connection to cabinet	560 (1' 10 1/16")	31430
	Connector top 110 mm (4 11/32"), for two pivot/slide-in doors	500 (1' 7 11/16")	31006
	Connector bottom 110 mm (4 11/32"), for two pivot/slide-in doors	500 (1' 7 11/16")	31246
	Connector bottom 110 mm (4 11/32"), for two pivot/slide-in doors (for installation in front of fixed plinth)	26 (1 1/32")	31007

**Guides**

	No.
	25680



**Accessories**

	No.
	31020



**Straightening fitting**

→ Details under accessories from page 265



**Aluminum rew**

	Nr.
	056.3192.072
	056.3192.079

**Aluminum anodized**

	No.
	056.3192.071
	056.3192.082
	056.3192.080

**Aluminum black anodized**

	No.
	056.3192.074
	056.3192.075
	056.3192.081

**Straightening fitting**

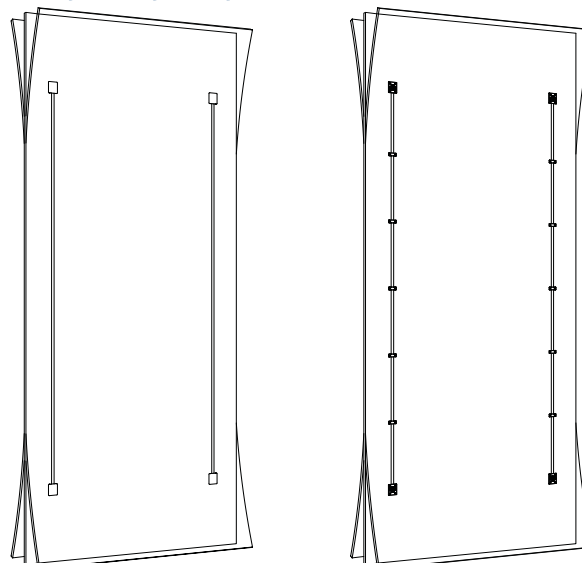

Further installation examples  
Composed cabinet

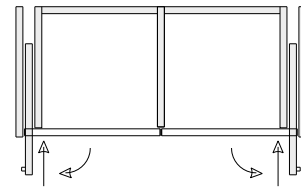
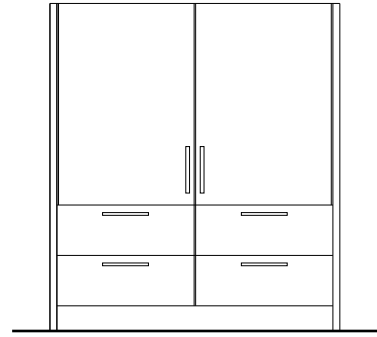
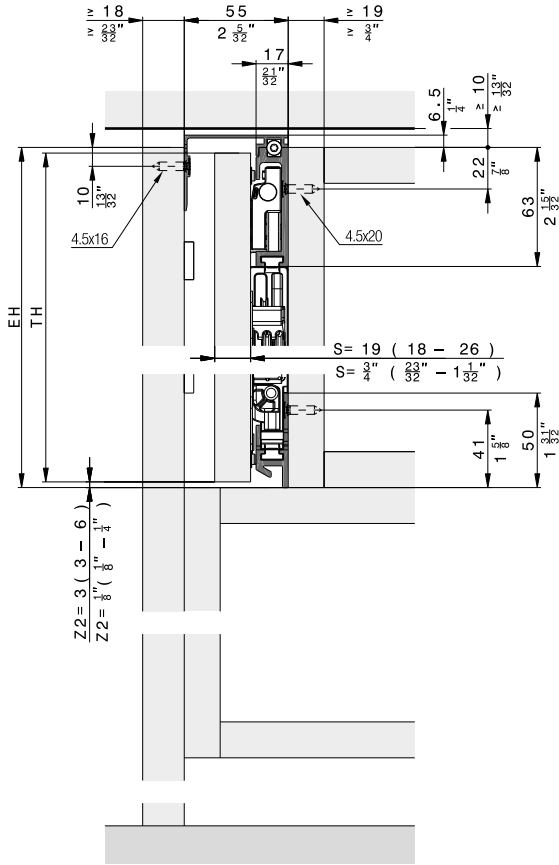

Cabinet without base panel

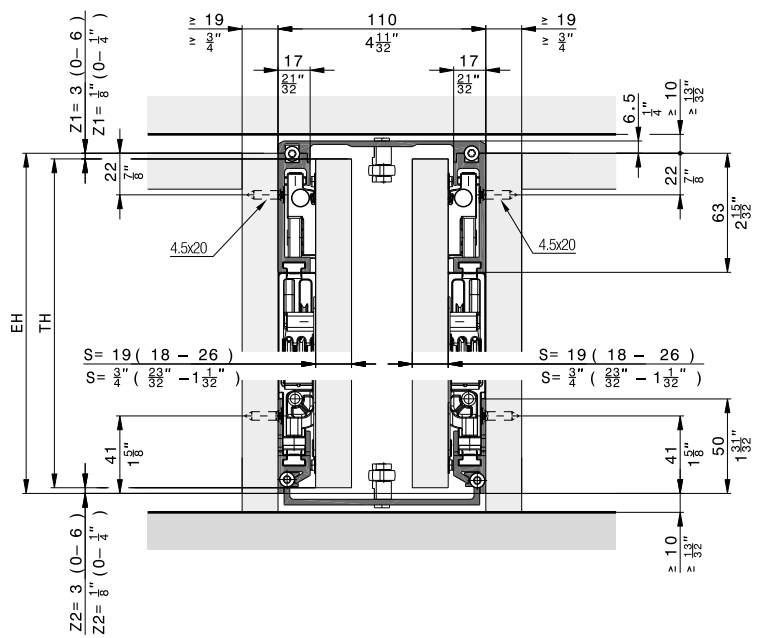
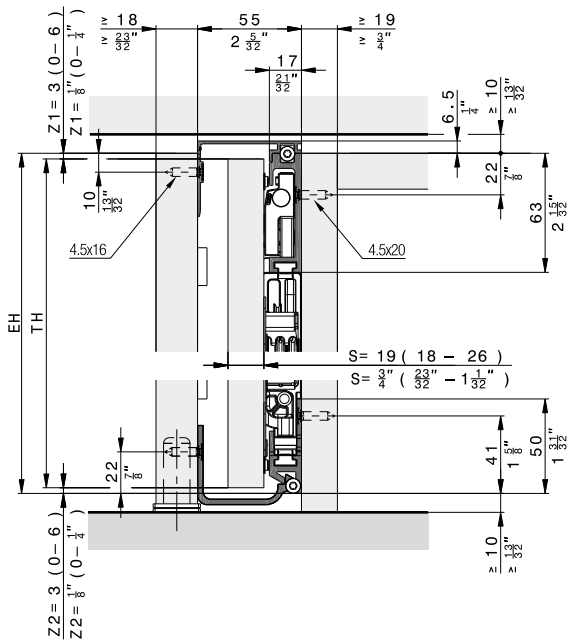

Inlaid doors

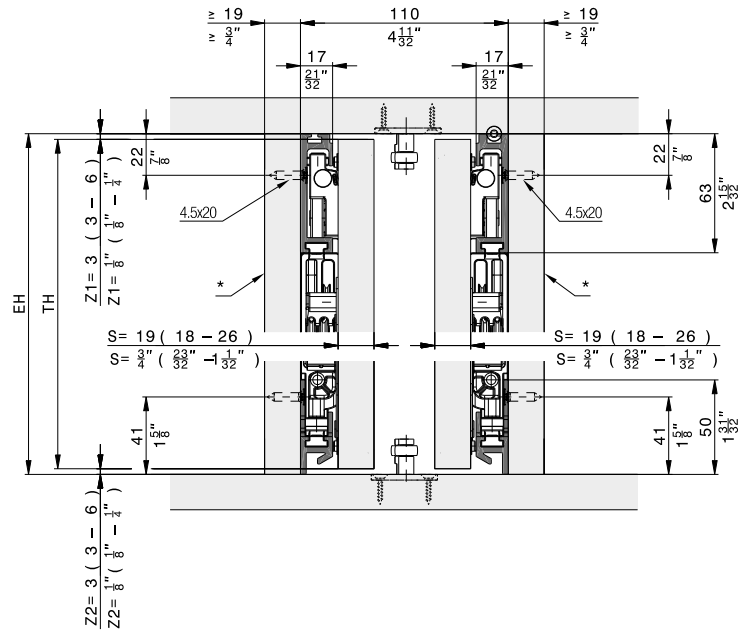
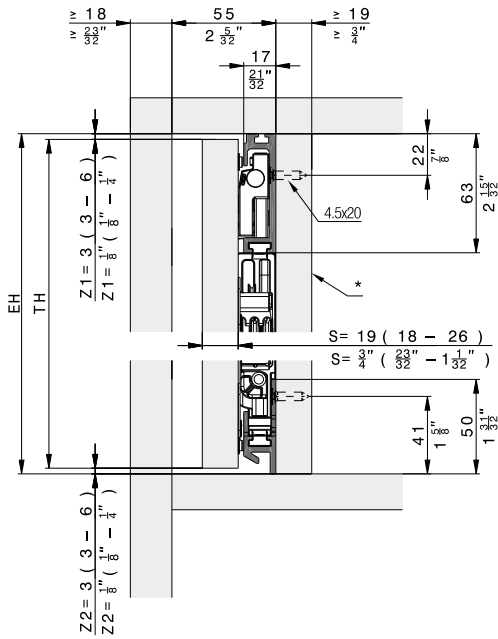

\* removable

Floor-to-ceiling doors

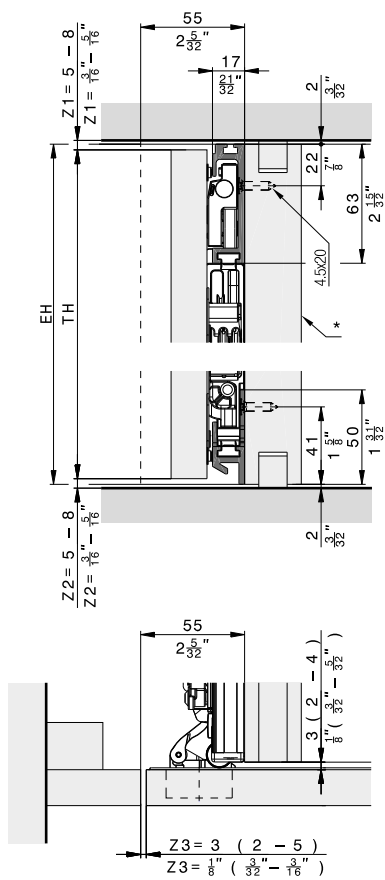

\* removable

Hardware depth calculation

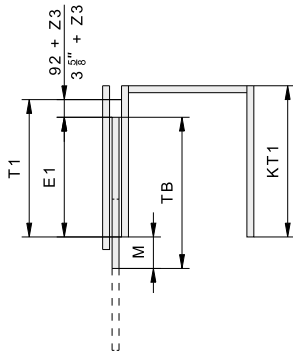

	mm	Inch
T1	≥ 414	≥ 1'4 <sup>5</sup> / <sub>16</sub> "

	mm	Inch
T1	TB + 92 + Z3 - M	TB + 3 <sup>5</sup> / <sub>8</sub> " + Z3 - M
E1	TB - M	TB - M
M	≥ S + 3 ≤ TB - 320	≥ S + <sup>5</sup> / <sub>8</sub> " ≤ TB - 1 <sup>19</sup> / <sub>32</sub> "

Door flush with outer face

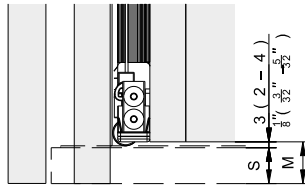

Protruding door

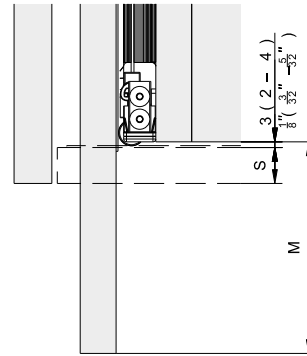

Instructions

- [Installation](#) →
- [Adjustment](#) →
- [Connector](#) →

Videos

- [Installation](#) →
- [Adjustment](#) →
- [Connector](#) →

Accessories

– Straightening fitting from page 265

Planning/execution

Configure with just a few clicks at [www.hawa.com/configurator](http://www.hawa.com/configurator)

Further information about the product can be found on [www.hawa.com](http://www.hawa.com).