

Concealed Hinges

Product Guide

	Cranking	Opening angle	Cup type	Page
T-type				
T-type-i 110	0mm	110°	for wood door	2.29
	5mm	110°	for wood door	2.29
	9mm	110°	for wood door	2.31
	17mm	110°	for wood door	2.31
T-type-i 110/15°	15°, 9mm	110°	for wood door	2.33
T-type-i 110/30°	30°, 9mm	110°	for wood door	2.35
T-type-i 110/45°	45°, 9mm	110°	for wood door	2.37
	45°, 17mm	110°	for wood door	2.39
	45° , 23 mm	110°	for wood door	2.41
T-type-i 110/90° for blind corner	90°, 17mm	110°	for wood door	2.43
T-type-i 120	0mm	120°	for wood door	2.49
T-type-i 95	0mm	95°	for wood door	2.47
	5mm	95°	for wood door	2.47
	9mm	95°	for wood door	2.49
	17mm	95°	for wood door	2.49
T-type 110	0mm	110°	for wood door	2.51
	5mm	110°	for wood door	2.51
	9mm	110°	for wood door	2.53
	17mm	110°	for wood door	2.53
T-type 110/15°	15°, 9mm	110°	for wood door	2.55
T-type 110/30°	30°, 9mm	110°	for wood door	2.57
T-type 110/45°	45°, 9mm	110°	for wood door	2.59
	45°, 17mm	110°	for wood door	2.61
T-type 110/90° for blind corner	90°, 17mm	110°	for wood door	2.63
T-type 120	0mm	120°	for wood door	2.33

	Cranking	Opening angle	Cup type	Page
T-type				
T-type 95	0mm	95°	for wood door	2.67
	5mm	95°	for wood door	2.67
	9mm	95°	for wood door	2.69
	17mm	95°	for wood door	2.69
T-type 110 PushOpen Hinge	0mm	110°	for wood door	2.71
	5mm	110°	for wood door	2.71
	9mm	110°	for wood door	2.73
T-type 170	0mm	170°	for wood door	2.75
	5mm	170°	for wood door	2.77
	9mm	170°	for wood door	2.77
T-type for pie-cut corner cabinet			for wood door	2.79
T-type mounting plates				2.81

T-type Hinges

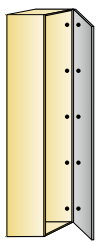

Easy door installation even in cases of 3-5 hinges per door

- Easy and quick assembly and disassembly

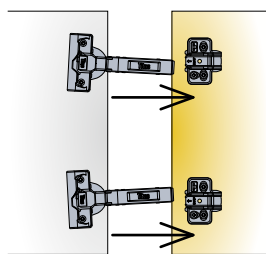

Highly tolerant

- Efficient performance in edge value of tolerances
- Reliable door closing in case of accidental misalignment
- ConfidentClose assured

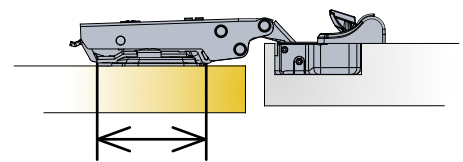

Rigidity

- Rigid hinge-to-plate attachment assures door stability
- Tight hinge-to-plate joint improves hinge stability and reduces door sag
- Smooth performance

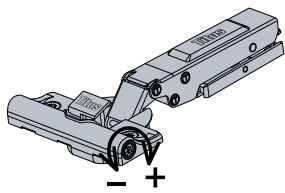
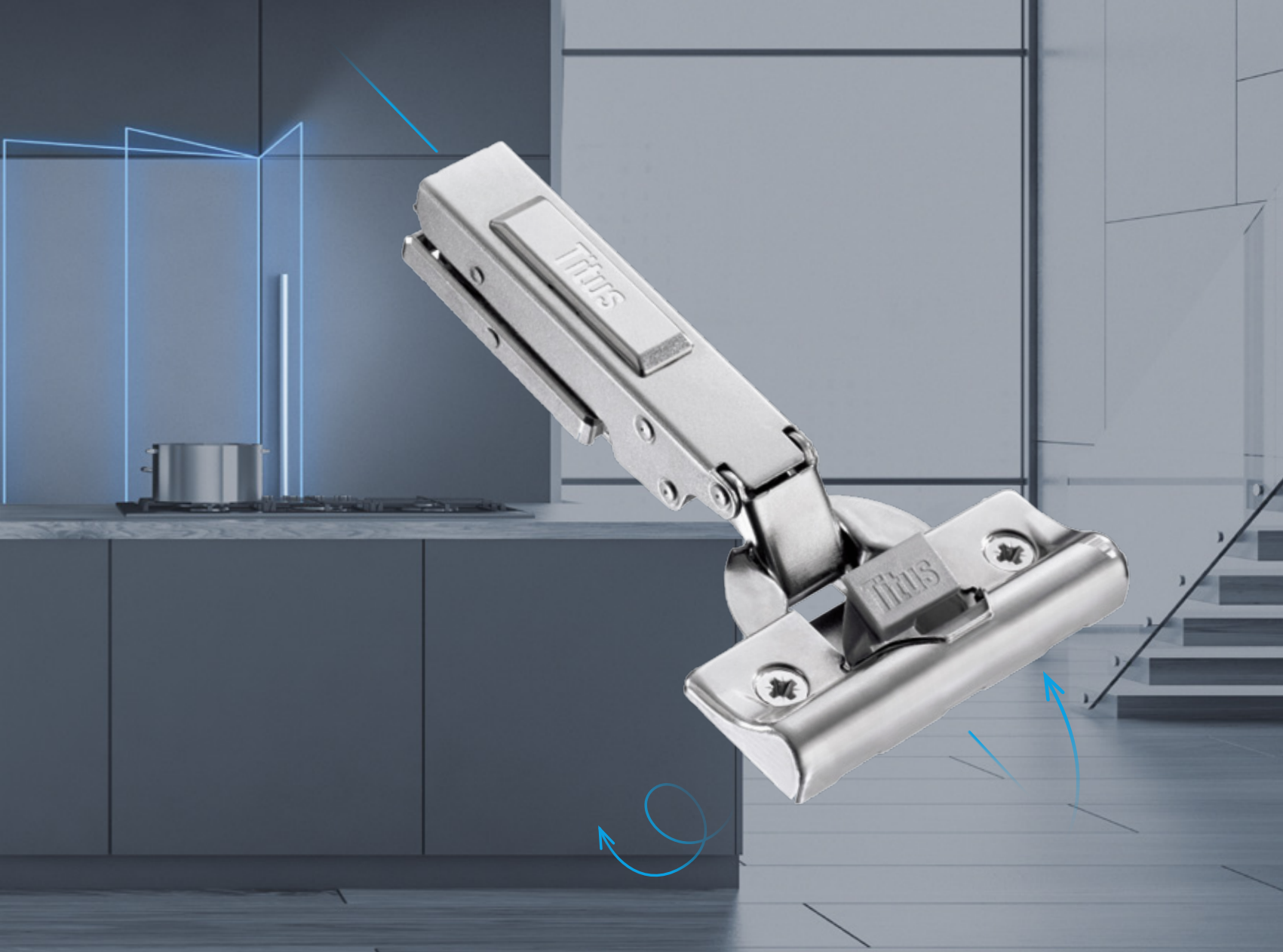

Adjustable damping

- Consistent performance on doors of different dimensions and weights
- Intuitive adjustment



Titus Damper Inside

- Titus proprietary multi-purpose damping technology
- Reliable and consistent life-long damping



Proven Glissando concept

- Damper is positioned transversal on the hinge cup
- Reliable performance

T-type-i 110

For wood doors

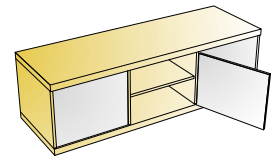
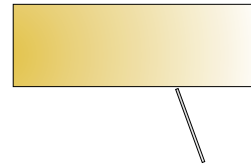
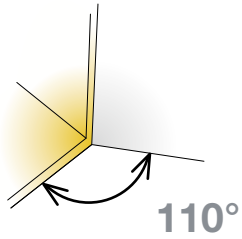

- Opening angle
- Drilling diameter for hinge cup
- Drilling depth
- Hinge on plate mounting system

110°
35mm
12mm
3Way snap-on



Technical details

Cup type	Interaxis 45mm	Interaxis 48mm
Item number		

Cranking
0mm

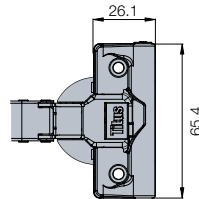
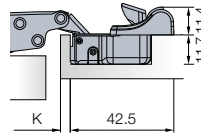
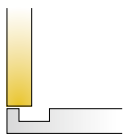

150 Pcs Made of steel

	701-0AT0-054	701-0AS0-054
	701-0AT1-054	701-0AS1-054
	701-0AT4-054	701-0AS4-054

Drilling patterns for hinge cups → see page 2.17

Cranking
5mm

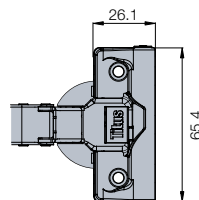
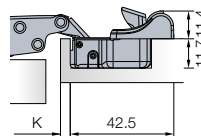
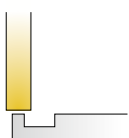

150 Pcs Made of steel

	701-0BT0-054	701-0BS0-054
	701-0BT1-054	701-0BS1-054
	701-0BT4-054	701-0BS4-054

Drilling patterns for hinge cups → see page 2.17

Mounting plates



Cam adjustable cruciform mounting plate
→ see page 2.81



Cruciform mounting plate
→ see page 2.83



Cam adjustable linear mounting plate
→ see page 2.81



Face frame adapter plate
→ see page 2.83

Hinge cup screws

If not pre-mounted

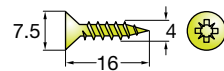

820-6328-050

10000 Pcs

Accessories



Cover caps for hinge arm
→ see page 2.177



Hinge angle restrictor
→ see page 2.175

Legend of hinge cup symbols

Screw-on ready
← screws

Machine insertion ready

EasyFix system

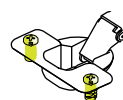
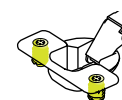

Damping adjustment

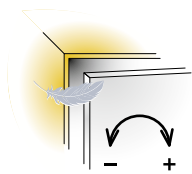

Door adjustment

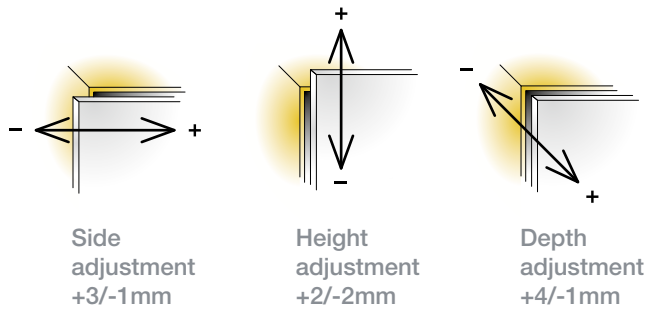

For further explanation → see page 2.25

For further explanation → see pages 2.22-2.24

Mounting details

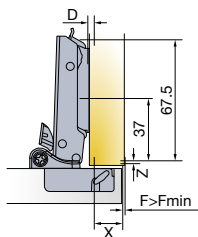
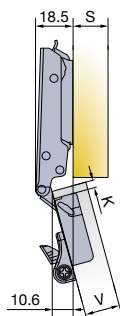

Mounting plate drilling distance

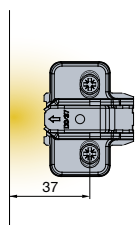

Mounting plate thickness table

For further explanation → see page 2.13

X	13	14	15	16	17	18	19
3	3	2	1	0			
4	4	3	2	1	0		
K							
5		4	3	2	1	0	
6			4	3	2	1	0
							D

$D=13+K-X$

Drawings show application on D=0mm mounting plate

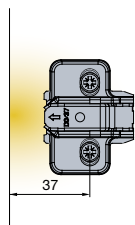
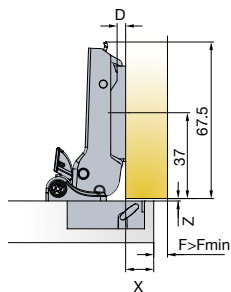
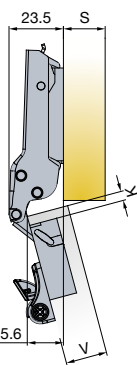

X	8	9	10	11	12	13	14
3	3	2	1	0			
4	4	3	2	1	0		
K							
5		4	3	2	1	0	
6			4	3	2	1	0
							D

$D=8+K-X$

Drawings show application on D=0mm mounting plate

Touch opening



PushOpen Solutions
→ see pages 2.199-2.204

Door clearance at R=1mm

For further explanation → see page 2.14

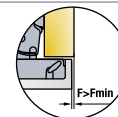

V	16	17	18	19	20	21	22	23	24	25	26
3	0.5	0.7	0.8	1	1.2	1.5	1.7	2.1	2.8	4.1	5.5
4	0.4	0.7	0.8	1	1.2	1.5	1.7	2.1	2.3	3.1	4.5
K											
5	0.4	0.6	0.7	0.9	1.1	1.4	1.6	2	2.2	2.6	3.5
6	0.4	0.6	0.7	0.9	1.1	1.4	1.6	2	2.2	2.6	2.9
											F _{MIN}

Gap Z_{MIN}=0

T-type-i 110

For wood doors

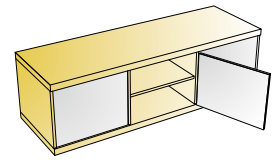
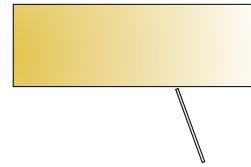
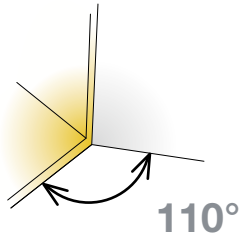

- Opening angle
- Drilling diameter for hinge cup
- Drilling depth
- Hinge on plate mounting system

110°
35mm
12mm
3Way snap-on



Technical details

Cup type	Interaxis 45mm	Interaxis 48mm
Item number		

Cranking
9mm

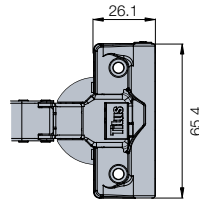
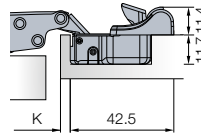
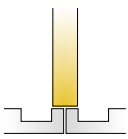

	701-OCT0-054	701-OCS0-054
	701-OCT1-054	701-OCS1-054
	701-OCT4-054	701-OCS4-054

Drilling patterns for hinge cups → see page 2.17

150 Pcs

Made of steel

Cranking
17mm

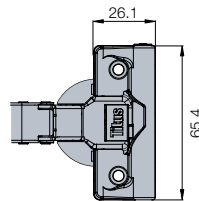
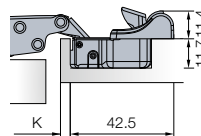
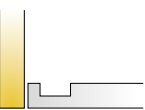

	701-ODT0-054	701-ODS0-054
	701-ODT1-054	701-ODS1-054
	701-ODT4-054	701-ODS4-054

Drilling patterns for hinge cups → see page 2.17

150 Pcs

Made of steel

Mounting plates



Cam adjustable cruciform mounting plate
→ see page 2.81



Cruciform mounting plate
→ see page 2.83



Cam adjustable linear mounting plate
→ see page 2.81



Face frame adapter plate
→ see page 2.83

Hinge cup screws

If not pre-mounted

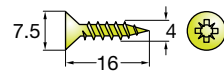

820-6328-050

10000 Pcs

Accessories



Cover caps for hinge arm
→ see page 2.177



Hinge angle restrictor
→ see page 2.175

Legend of hinge cup symbols

Screw-on ready
← screws

Machine insertion ready

EasyFix system

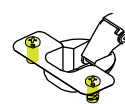
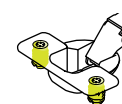
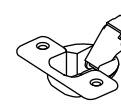

Damping adjustment

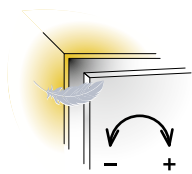

Door adjustment

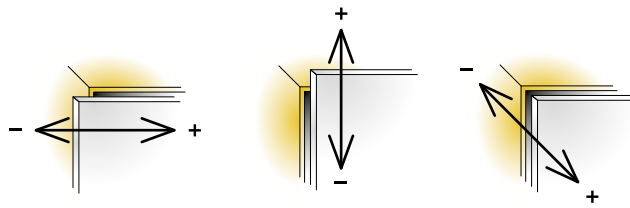

Side adjustment
+3/-1mm

Height adjustment
+2/-2mm

Depth adjustment
+4/-1mm

For further explanation → see page 2.25

For further explanation → see pages 2.22-2.24

Mounting details

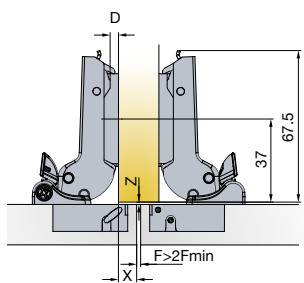
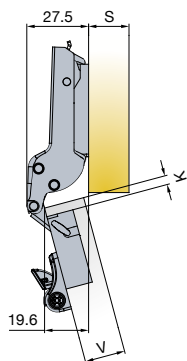

Mounting plate drilling distance

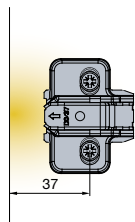

Mounting plate thickness table

For further explanation → see page 2.13

X	4	5	6	7	8	9	10
3	3	2	1	0			
4	4	3	2	1	0		
5		4	3	2	1	0	
6			4	3	2	1	0

$D=4+K-X$

Drawings show application on D=0mm mounting plate

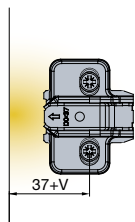
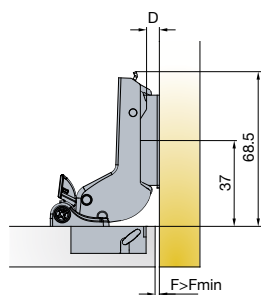
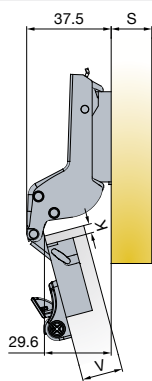

V	16	17	18	19	20	21	22	23	24
3	0	0	0	0	1	1	1	1	2
4	1	1	1	1	2	2	2	2	3
5	2	2	2	2	3	3	3	3	4
6	3	3	3	3	4	4	4	4	D

$D=-4+K+F$

Drawings show application on D=2mm mounting plate

Touch opening



PushOpen Solutions
→ see pages 2.199-2.204

Door clearance at R=1mm

For further explanation → see page 2.14

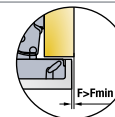

V	16	17	18	19	20	21	22	23	24	25	26
3	0.5	0.7	0.8	1	1.2	1.5	1.7	2.1	2.8	4.1	5.5
4	0.4	0.7	0.8	1	1.2	1.5	1.7	2.1	2.3	3.1	4.5
5	0.4	0.6	0.7	0.9	1.1	1.4	1.6	2	2.2	2.6	3.5
6	0.4	0.6	0.7	0.9	1.1	1.4	1.6	2	2.2	2.6	2.9 F _{MIN}

Gap Z_{MIN}=0

T-type-i 110/15°

15° angled application for wood doors

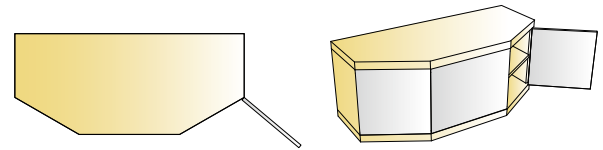
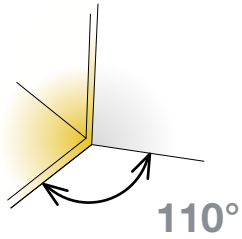

- Opening angle 110°
- Drilling diameter for hinge cup 35mm
- Drilling depth 12mm
- Hinge on plate mounting system 3Way snap-on



Technical details

Cup type	Interaxis 45mm	Interaxis 48mm
	Item number	Item number

Cranking
9mm

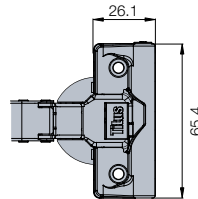
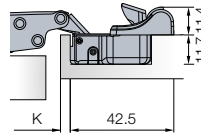
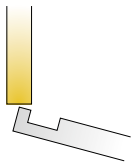

	701-0D64-650	701-0D66-650
	701-0D70-650	701-0D72-650
	701-0D76-650	701-0D78-650

Drilling patterns for hinge cups → see page 2.17

100 Pcs

Cup made of steel, arm made of zinc

Mounting plates

Cam adjustable cruciform mounting plate
→ see page 2.81

Cruciform mounting plate
→ see page 2.83

Cam adjustable linear mounting plate
→ see page 2.81

Face frame adapter plate
→ see page 2.83

Hinge cup screws

If not pre-mounted

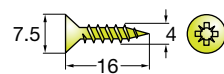

820-6328-050

10000 Pcs

Accessories



Cover caps for hinge arm
→ see page 2.177

Hinge angle restrictor
→ see page 2.175

Legend of hinge cup symbols

Screw-on ready
← screws

Machine insertion ready

EasyFix system

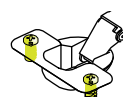
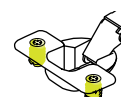
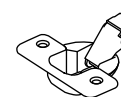

Damping adjustment

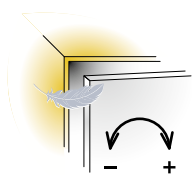

Door adjustment

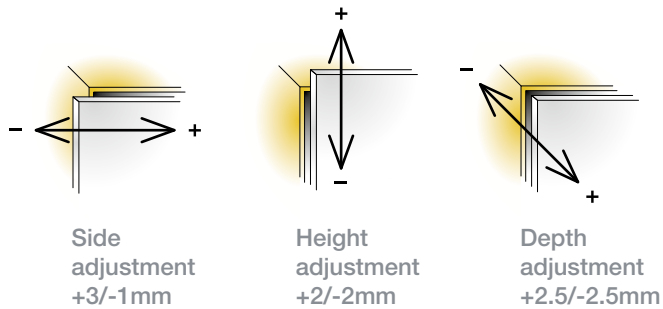

Side adjustment
+3/-1mm

Height adjustment
+2/-2mm

Depth adjustment
+2.5/-2.5mm

For further explanation → see page 2.25

For further explanation → see pages 2.22-2.24

Mounting details

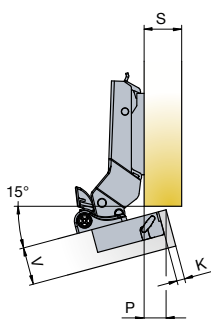
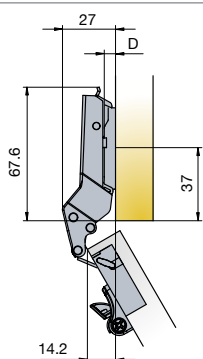

Mounting plate drilling distance

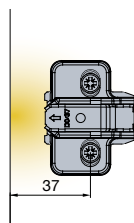

Mounting plate thickness table

For further explanation → see page 2.13

P	11	12	13	14	15	16	17	18
3	4	3	2	1	0			
4		4	3	2	1	0		
5			4	3	2	1	0	
6				4	3	2	1	0 D

Drawings show application on D=0mm mounting plate

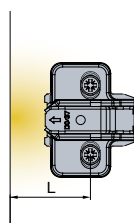
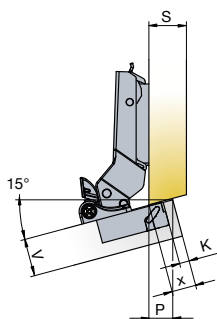
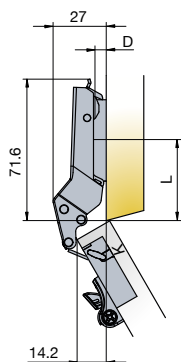

P	6	7	8	9	10	11	12	13
3	4	3	2	1	0			
4		4	3	2	1	0		
5			4	3	2	1	0	
6				4	3	2	1	0 D

Drawings show application on D=0mm mounting plate

L=45 for thickness D=0
L=44 for thickness D=1
L=43 for thickness D=2
L=42 for thickness D=3
L=41 for thickness D=4

Touch opening



PushOpen Solutions
→ see pages 2.199-2.204

Door clearance at R=1mm

For further explanation → see page 2.14

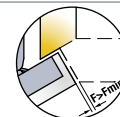

V	16	17	18	19	20	21	22	23	24	25	26
3	0.5	0.7	0.8	1	1.2	1.5	1.7	2.1	2.8	4.1	5.5
4	0.4	0.7	0.8	1	1.2	1.5	1.7	2.1	2.3	3.1	4.5
5	0.4	0.6	0.7	0.9	1.1	1.4	1.6	2	2.2	2.6	3.5
6	0.4	0.6	0.7	0.9	1.1	1.4	1.6	2	2.2	2.6	2.9 F _{MIN}

Gap Z_{MIN}=0

T-type-i 110/30°

30° angled application for wood doors

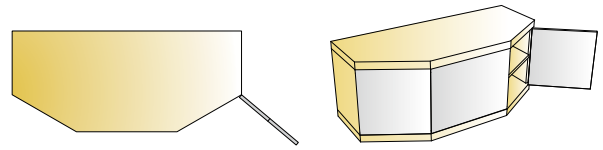
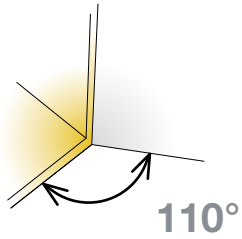

- Opening angle 110°
- Drilling diameter for hinge cup 35mm
- Drilling depth 12mm
- Hinge on plate mounting system 3Way snap-on



Technical details

Cup type	Interaxis 45mm	Interaxis 48mm
Item number	Item number	Item number
	701-0E52-650	701-0E54-650
	701-0E58-650	701-0E60-650
	701-0E64-650	701-0E66-650

Drilling patterns for hinge cups → see page 2.17

Cranking
9mm

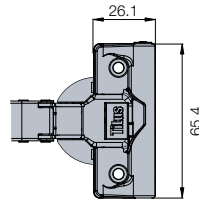
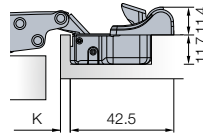
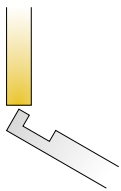

100 Pcs

Cup made of steel, arm made of zinc

Mounting plates



Cam adjustable cruciform mounting plate
→ see page 2.81



Cruciform mounting plate
→ see page 2.83



Cam adjustable linear mounting plate
→ see page 2.81



Face frame adapter plate
→ see page 2.83

Hinge cup screws

If not pre-mounted

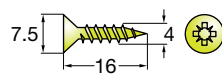

820-6328-050

10000 Pcs

Accessories



Cover caps for hinge arm
→ see page 2.177



Hinge angle restrictor
→ see page 2.175

Legend of hinge cup symbols



Screw-on ready
← screws



Machine insertion ready



EasyFix system

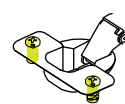
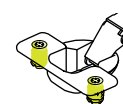
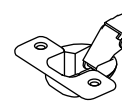

Damping adjustment

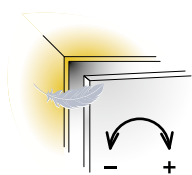

Door adjustment

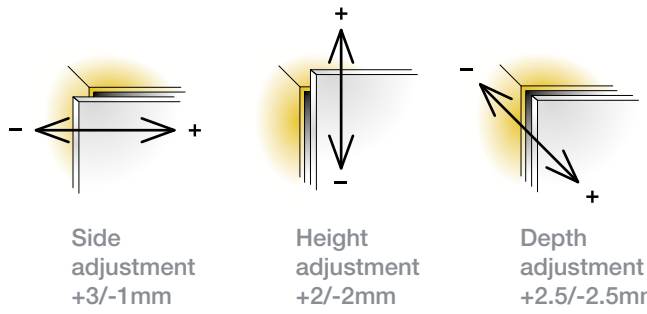

For further explanation → see page 2.25

For further explanation → see pages 2.22-2.24

Mounting details

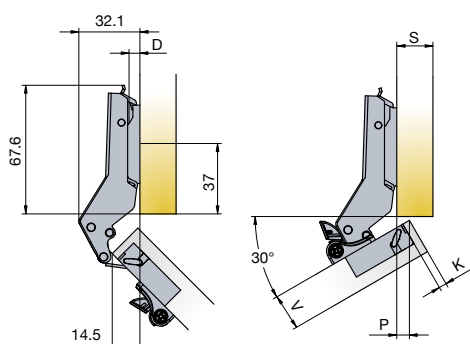

Mounting plate drilling distance

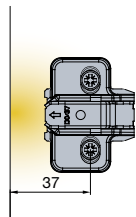

Mounting plate thickness table

For further explanation → see page 2.13

P	1.5	2.5	3.5	4.5	5.5	6.5	7.5	8.5
3	4	3	2	1	0			
4		4	3	2	1	0		
5			4	3	2	1	0	
6				4	3	2	1	0

Drawings show application on D=0mm mounting plate

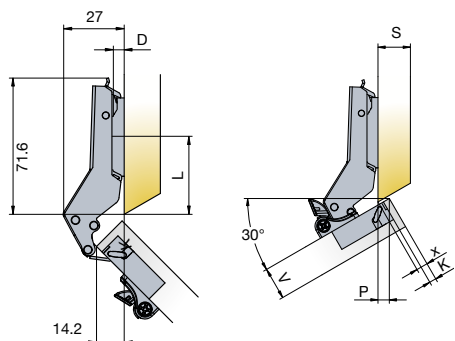

X	2	3	4	5	6	7	8	9
3	4	3	2	1	0			
4		4	3	2	1	0		
5			4	3	2	1	0	
6				4	3	2	1	0

Drawings show application on D=0mm mounting plate

L=41 for thickness D=0
 L=41 for thickness D=1
 L=40 for thickness D=2
 L=40 for thickness D=3
 L=39 for thickness D=4

Touch opening



PushOpen Solutions
 → see pages 2.199-2.204

Door clearance at R=1mm

For further explanation → see page 2.14

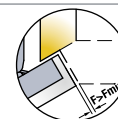

V	16	17	18	19	20	21	22	23	24	25	26
3	0.5	0.7	0.8	1	1.2	1.5	1.7	2.1	2.8	4.1	5.5
4	0.4	0.7	0.8	1	1.2	1.5	1.7	2.1	2.3	3.1	4.5
5	0.4	0.6	0.7	0.9	1.1	1.4	1.6	2	2.2	2.6	3.5
6	0.4	0.6	0.7	0.9	1.1	1.4	1.6	2	2.2	2.6	2.9

Gap Z_{MIN}=0

T-type-i 110/45°

45° angled application for wood doors

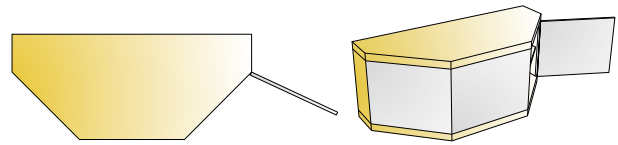
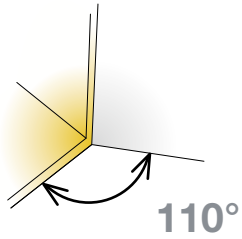

- Opening angle 110°
- Drilling diameter for hinge cup 35mm
- Drilling depth 12mm
- Hinge on plate mounting system 3Way snap-on



Technical details

Cup type	Interaxis 45mm	Interaxis 48mm
Item number	Item number	Item number
	701-0D82-650	701-0D84-650
	701-0D88-650	701-0D90-650
	701-0D98-650	701-0E32-650

Cranking
9mm

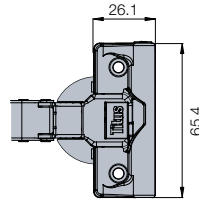
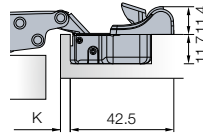
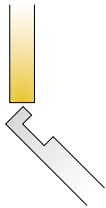

Drilling patterns for hinge cups → see page 2.17

100 Pcs

Cup made of steel, arm made of zinc

Mounting plates

Cam adjustable cruciform mounting plate
→ see page 2.81

Cruciform mounting plate
→ see page 2.83

Cam adjustable linear mounting plate
→ see page 2.81

Face frame adapter plate
→ see page 2.83

Hinge cup screws
If not pre-mounted
 7.5
16

820-6328-050
 10000 Pcs

Accessories
 Thin
 Thick

Hinge angle restrictor
→ see page 2.175

Cover caps for hinge arm
→ see page 2.177

Legend of hinge cup symbols

Screw-on ready
← screws

Machine insertion ready

EasyFix system

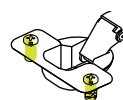
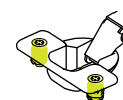
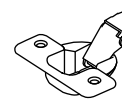

Damping adjustment

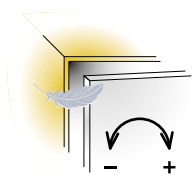

Door adjustment

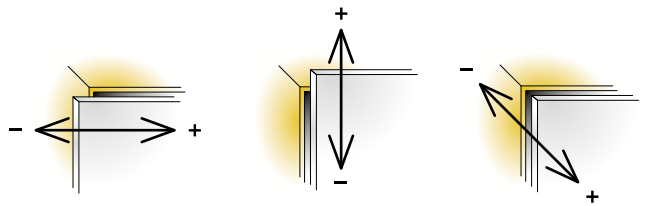

Side adjustment
+3/-1mm

Height adjustment
+2/-2mm

Depth adjustment
+2.5/-2.5mm

For further explanation → see page 2.25

For further explanation → see pages 2.22-2.24

Mounting details

Mounting plate drilling distance

Mounting plate thickness table

For further explanation → see page 2.13

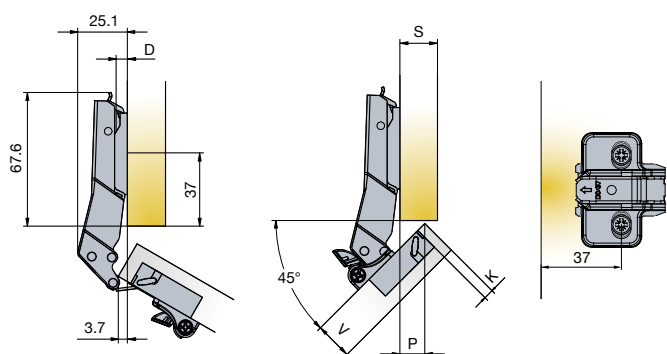

P	7	7.5	8	8.5	9	9.5	10	10.5	11	11.5	12	12.5	13	13.5
3	4		3		2		1		0					
4			4		3		2		1		0			
5				4	3		2		1		0			
6						4	3		2		1		0	

Drawings show application on D=0mm mounting plate

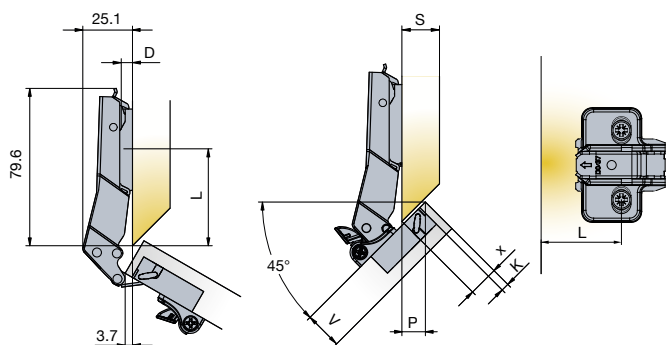

X	10	11	12	13	14	15	16	17
3	4	3	2	1	0			
4		4	3	2	1	0		
5			4	3	2	1	0	
6				4	3	2	1	0 D

Drawings show application on D=0mm mounting plate

L=49 for thickness D=0
L=48 for thickness D=1
L=47 for thickness D=2
L=46 for thickness D=3
L=45 for thickness D=4

Touch opening



PushOpen Solutions
→ see pages 2.199-2.204

Door clearance at R=1mm

For further explanation → see page 2.14

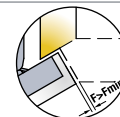

V	16	17	18	19	20	21	22	23	24	25	26
3	0.5	0.7	0.8	1	1.2	1.5	1.7	2.1	2.8	4.1	5.5
4	0.4	0.7	0.8	1	1.2	1.5	1.7	2.1	2.3	3.1	4.5
5	0.4	0.6	0.7	0.9	1.1	1.4	1.6	2	2.2	2.6	3.5
6	0.4	0.6	0.7	0.9	1.1	1.4	1.6	2	2.2	2.6	2.9 F _{MIN}

Gap Z_{MIN}=0

T-type-i 110/45°

45° angled application for wood doors

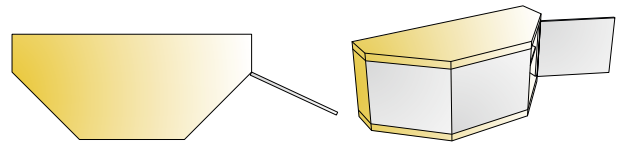
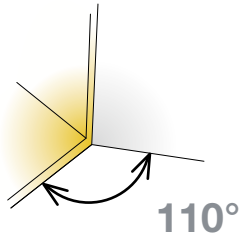

- Opening angle 110°
- Drilling diameter for hinge cup 35mm
- Drilling depth 12mm
- Hinge on plate mounting system 3Way snap-on



Technical details

Cup type	Interaxis 45mm	Interaxis 48mm
	<p>45 9.5 Ø 35</p>	<p>48 6 Ø 35</p>
Item number	Item number	Item number
	701-0B08-650	701-0B10-650
	701-0C78-650	701-0C80-650
	701-0C54-650	701-0C56-650

Cranking
17mm

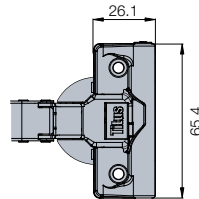
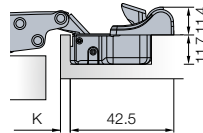
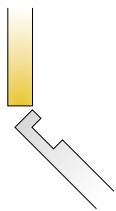

Drilling patterns for hinge cups → see page 2.17

100 Pcs

Cup made of steel, arm made of zinc

Mounting plates

Cam adjustable cruciform mounting plate
→ see page 2.81

Cruciform mounting plate
→ see page 2.83

Cam adjustable linear mounting plate
→ see page 2.81

Face frame adapter plate
→ see page 2.83

Hinge cup screws
If not pre-mounted
 7.5
16

820-6328-050
10000 Pcs

Accessories

Cover caps for hinge arm
→ see page 2.177

Hinge angle restrictor
→ see page 2.175

Legend of hinge cup symbols

Screw-on ready
← screws

Machine insertion ready

EasyFix system

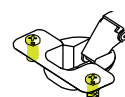
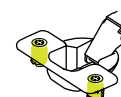

Damping adjustment

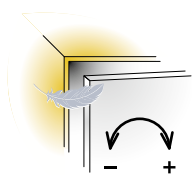

Door adjustment

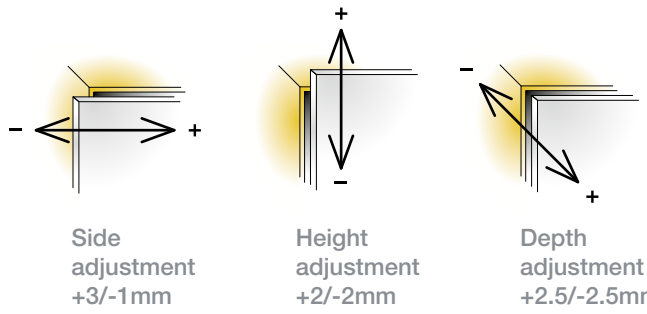

For further explanation → see page 2.25

For further explanation → see pages 2.22-2.24

Mounting details

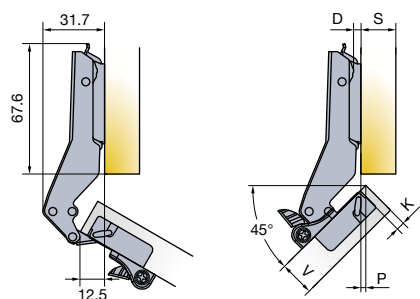

Mounting plate drilling distance

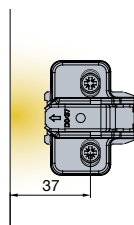

Mounting plate thickness table

For further explanation → see page 2.13

P	0	0.5	1	1.5	2	2.5	3	3.5	4
3		2		1		0			
4	3		2		1		0		
5		3		2		1		0	
6	4		3		2		1		0

Drawings show application on D=0mm mounting plate

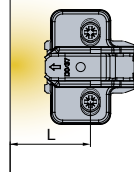
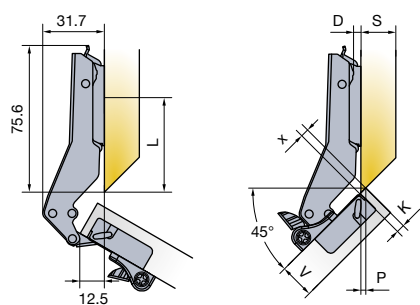

X	0	0.5	1	1.5	2	2.5	3	3.5	4	4.5	5	6
3	2			1			0					
4			2			1			0			
5		3			2			1			0	
6	4			3			2			1		0

Drawings show application on D=0mm mounting plate

L=45 for thickness D=0
 L=44 for thickness D=1
 L=43 for thickness D=2
 L=42 for thickness D=3
 L=41 for thickness D=4

Touch opening



PushOpen Solutions
 → see pages 2.199-2.204

Door clearance at R=1mm

For further explanation → see page 2.14

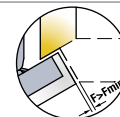

V	16	17	18	19	20	21	22	23	24	25	26
3	0.5	0.7	0.8	1	1.2	1.5	1.7	2.1	2.8	4.1	5.5
4	0.4	0.7	0.8	1	1.2	1.5	1.7	2.1	2.3	3.1	4.5
5	0.4	0.6	0.7	0.9	1.1	1.4	1.6	2	2.2	2.6	3.5
6	0.4	0.6	0.7	0.9	1.1	1.4	1.6	2	2.2	2.6	2.9

Gap Z_{MIN}=0

T-type-i 110/45°

45° angled application for wood doors

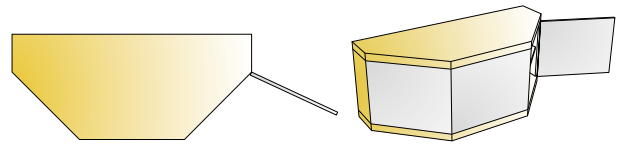
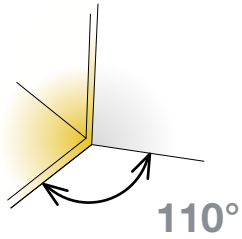

- Opening angle 110°
- Drilling diameter for hinge cup 35mm
- Drilling depth 12mm
- Hinge on plate mounting system 3Way snap-on



Technical details

Cup type	Interaxis 45mm	Interaxis 48mm
	<p>45 9.5 Ø 35</p>	<p>48 6 Ø 35</p>
Item number	Item number	Item number
	701-0W59-650	701-0W60-650
	701-0W62-650	701-0W63-650
	701-0W65-650	701-0W66-650

Cranking
23mm

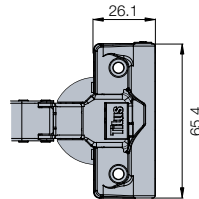
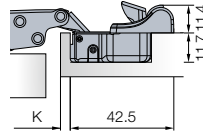
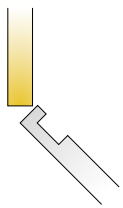

Drilling patterns for hinge cups → see page 2.17

100 Pcs

Cup made of steel, arm made of zinc

Mounting plates

Cam adjustable cruciform mounting plate
→ see page 2.81

Cruciform mounting plate
→ see page 2.83

Cam adjustable linear mounting plate
→ see page 2.81

Face frame adapter plate
→ see page 2.83

Hinge cup screws
If not pre-mounted
 7.5
16

820-6328-050
10000 Pcs

Accessories

Cover caps for hinge arm
→ see page 2.177

Hinge angle restrictor
→ see page 2.175

Legend of hinge cup symbols

Screw-on ready
← screws

Machine insertion ready

EasyFix system

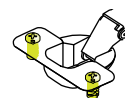
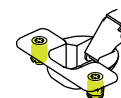

Damping adjustment

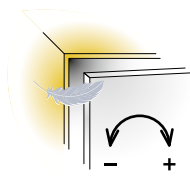

Door adjustment

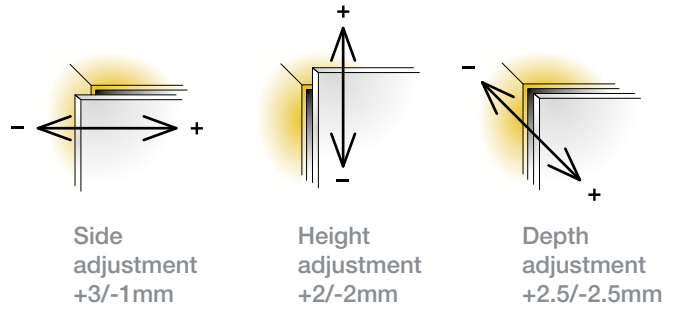

For further explanation → see page 2.25

For further explanation → see pages 2.22-2.24

Mounting details

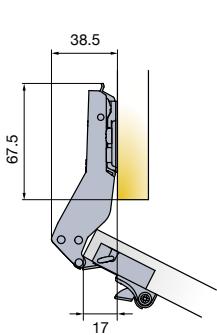

Mounting plate drilling distance

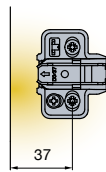
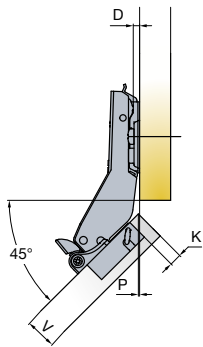

Mounting plate thickness table

For further explanation → see page 2.13

P	7.5	7	6.5	6	5.5	5	4.5	4	3.5	3	2.5	2	1.5
3	4		3		2		1		0				
4		4		3		2		1		0			
5				4		3		2		1		0	
6					4		3		2		1		0

Touch opening



PushOpen Solutions
→ see pages 2.199-2.204

Door clearance at R=1mm

For further explanation → see page 2.14

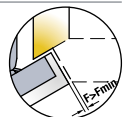

V	16	17	18	19	20	21	22	23	24	25	26
3	0.5	0.7	0.8	1	1.2	1.5	1.7	2.1	2.8	4.1	5.5
4	0.4	0.7	0.8	1	1.2	1.5	1.7	2.1	2.3	3.1	4.5
5	0.4	0.6	0.7	0.9	1.1	1.4	1.6	2	2.2	2.6	3.5
6	0.4	0.6	0.7	0.9	1.1	1.4	1.6	2	2.2	2.6	2.9 F _{MIN}

Gap Z_{MIN}=0

T-type-i 110/90°

For wood door cabinets with blind panels

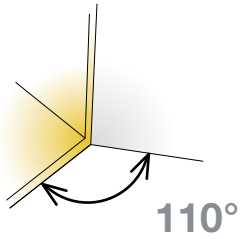
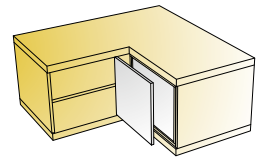

- Opening angle 110°
- Drilling diameter for hinge cup 35mm
- Drilling depth 12mm
- Hinge on plate mounting system 3Way snap-on



Technical details

Cup type	Interaxis 45mm	Interaxis 48mm
	Item number	Item number

Cranking
17mm

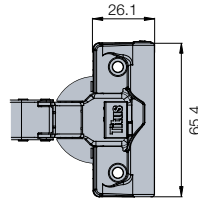
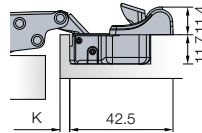
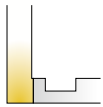

	701-0A96-650	701-0A98-650
	701-0D36-650	701-0D38-650
	701-0D30-650	701-0D32-650

Drilling patterns for hinge cups → see page 2.17

100 Pcs

Cup made of steel, arm made of zinc

Mounting plates



Cam adjustable cruciform mounting plate
→ see page 2.81



Cruciform mounting plate
→ see page 2.83



Cam adjustable linear mounting plate
→ see page 2.81



Face frame adapter plate
→ see page 2.83

Hinge cup screws

If not pre-mounted

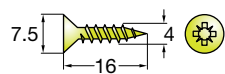

820-6328-050

10000 Pcs

Accessories



Cover caps for hinge arm
→ see page 2.177



Hinge angle restrictor
→ see page 2.175

Legend of hinge cup symbols

Screw-on ready
← screws

Machine insertion ready

EasyFix system

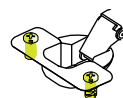
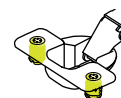

Damping adjustment

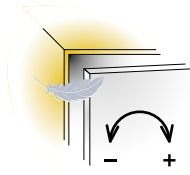

Door adjustment

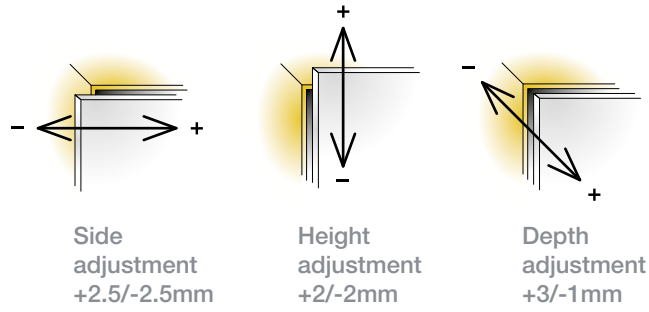

For further explanation → see page 2.25

For further explanation → see pages 2.22-2.24

Mounting details

Mounting plate drilling distance

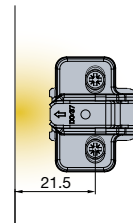
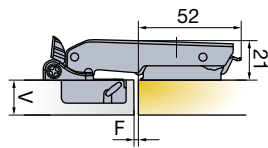
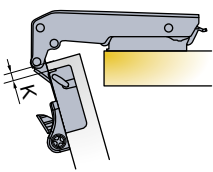

Drawing shows application on D=2mm mounting plate

Drawing shows application on D=2mm mounting plate

Touch opening



PushOpen Solutions
→ see pages 2.199-2.204

Door clearance at R=1mm

For further explanation → see page 2.14

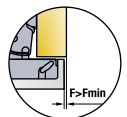

V	16	17	18	19	20	21	22	23	24	25	26
3	0.5	0.7	0.8	1	1.2	1.5	1.7	2.1	2.8	4.1	5.5
4	0.4	0.7	0.8	1	1.2	1.5	1.7	2.1	2.3	3.1	4.5
K											
5	0.4	0.6	0.7	0.9	1.1	1.4	1.6	2	2.2	2.6	3.5
6	0.4	0.6	0.7	0.9	1.1	1.4	1.6	2	2.2	2.6	2.9 F _{MIN}

Gap Z_{MIN}=0

T-type-i 120

For wood doors

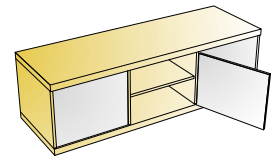
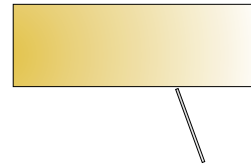
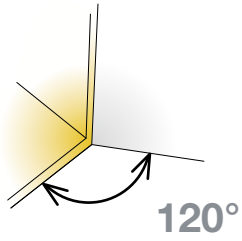

- Opening angle
- Drilling diameter for hinge cup
- Drilling depth
- Hinge on plate mounting system

120°
35mm
12mm
3Way snap-on



Technical details

Cup type	Interaxis 45mm	Interaxis 48mm
Item number	701-OUT0-054	701-0US0-054
Item number	701-OUT1-054	701-0US1-054
EasyFix	701-OUT4-054	701-0US4-054

Drilling patterns for hinge cups → see page 2.17

Cranking
0mm

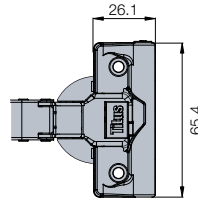
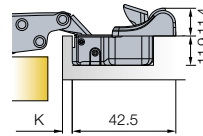
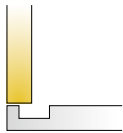

150 Pcs

Made of steel

Mounting plates



Cam adjustable cruciform mounting plate
→ see page 2.81



Cruciform mounting plate
→ see page 2.83



Cam adjustable linear mounting plate
→ see page 2.81



Face frame adapter plate
→ see page 2.83

Hinge cup screws

If not pre-mounted

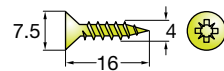

820-6328-050

10000 Pcs

Accessories



Cover caps for hinge arm
→ see page 2.177

Legend of hinge cup symbols



Screw-on ready
← screws



Machine insertion ready



EasyFix system

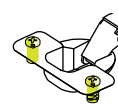
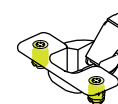
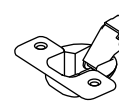

Damping adjustment

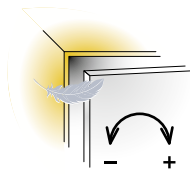

For further explanation → see page 2.25

Door adjustment

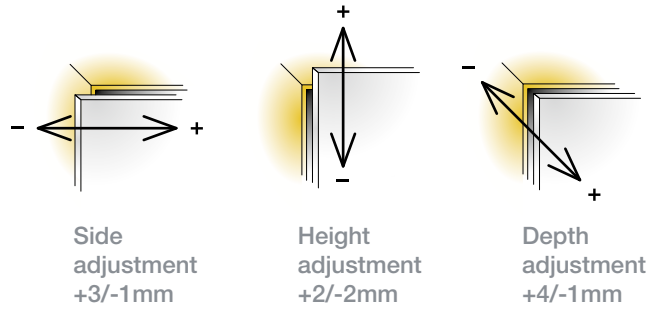

Side adjustment
+3/-1mm

Height adjustment
+2/-2mm

Depth adjustment
+4/-1mm

For further explanation → see pages 2.22-2.24

Mounting details

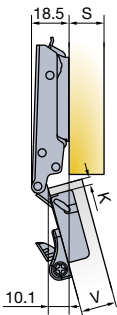

Drawings show application on D=0mm mounting plate

Mounting plate drilling distance

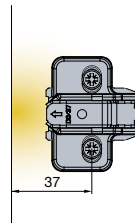
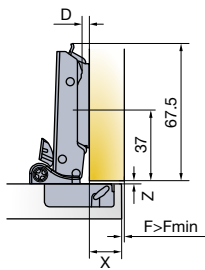

Mounting plate thickness table

For further explanation → see page 2.13

X	13	14	15	16	17	18	19
3	3	2	1	0			
4	4	3	2	1	0		
K		4	3	2	1	0	
6			4	3	2	1	0

$D=13+K-X$

Touch opening



PushOpen Solutions
→ see pages 2.199-2.204

Door clearance at R=1mm

For further explanation → see page 2.14

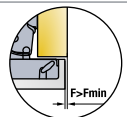

V	16	17	18	19
3	1.1	0.4	0	0
K	4	2	1.4	0.7
	5	3	2.3	1

Gap Z_{MIN} =2

T-type-i 95 Thick Door Hinge

For wood doors

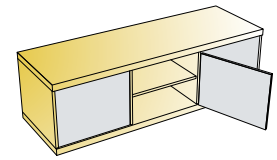
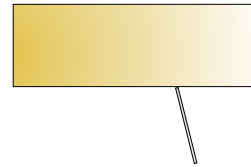
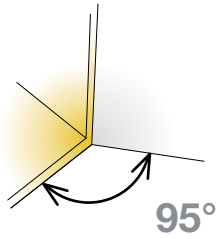

- Opening angle
- Drilling diameter for hinge cup
- Drilling depth
- Hinge on plate mounting system

95°
35mm
12mm
3Way snap-on



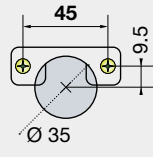
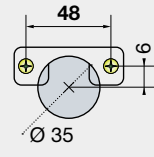

Technical details

	Interaxis 45mm	Interaxis 48mm
Cup type	 Ø 35	 Ø 35
Item number		

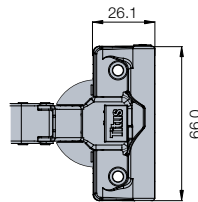
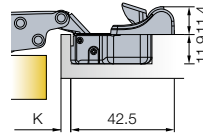
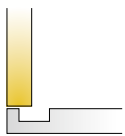
Cranking
0mm







	708-0XT0-054	708-0XS0-054
	708-0XT1-054	708-0XS1-054
	708-0XT4-054	708-0XS4-054

Drilling patterns for hinge cups → see page 2.17

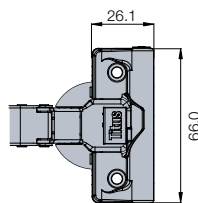
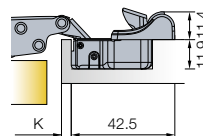
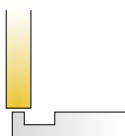
 150 Pcs Made of steel

Cranking
5mm



	708-0YT0-054	708-0YS0-054
	708-0YT1-054	708-0YS1-054
	708-0YT4-054	708-0YS4-054

Drilling patterns for hinge cups → see page 2.17

 150 Pcs Made of steel

Mounting plates



Cam adjustable cruciform mounting plate
→ see page 2.81



Cruciform mounting plate
→ see page 2.83





Cam adjustable linear mounting plate
→ see page 2.81

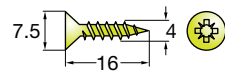

Face frame adapter plate
→ see page 2.83

Hinge cup screws If not pre-mounted



820-6328-050
 10000 Pcs

Accessories



Cover caps for hinge arm
→ see page 2.177

Legend of hinge cup symbols

 Screw-on ready
← screws

 Machine insertion ready

 EasyFix system

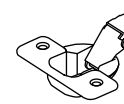

Touch opening

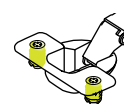

PushOpen Solutions
→ see pages 2.199-2.204

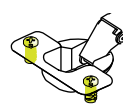

Damping adjustment

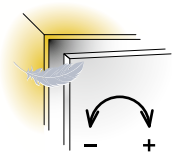

Door adjustment

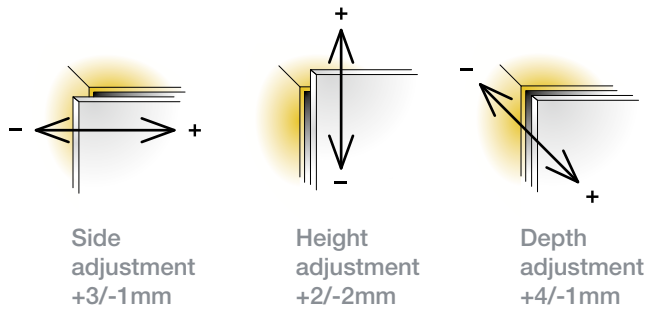

Side adjustment
+3/-1mm

Height adjustment
+2/-2mm

Depth adjustment
+4/-1mm

For further explanation → see page 2.25

For further explanation → see pages 2.22-2.24

Mounting details

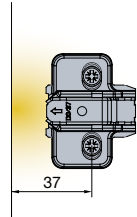
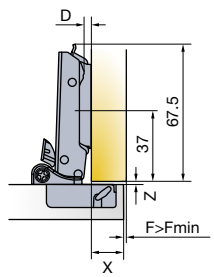
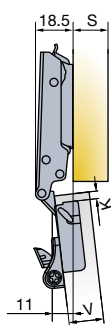

Drawings show application on D=0mm mounting plate

Mounting plate drilling distance

Mounting plate thickness table

For further explanation → see page 2.13

X	13	14	15	16	17	18	19	20	21	22
3	3	2	1	0						
4	4	3	2	1	0					
5		4	3	2	1	0				
K 6			4	3	2	1	0			
7				4	3	2	1	0		
8					4	3	2	1	0	
9						4	3	2	1	0

$D=13+K-X$

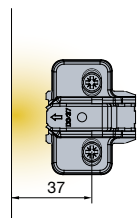
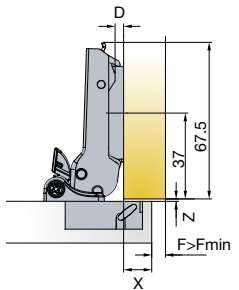
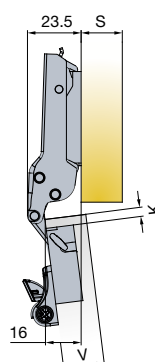

Drawings show application on D=0mm mounting plate

X	8	9	10	11	12	13	14	15	16	17
3	3	2	1	0						
4	4	3	2	1	0					
5		4	3	2	1	0				
K 6			4	3	2	1	0			
7				4	3	2	1	0		
8					4	3	2	1	0	
9						4	3	2	1	0

$D=8+K-X$

Gap Z

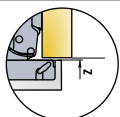

V	20	22	24	26	28	30	32	34	
3	0	0	0	0	0	0	0	0	
4	0	0	0	0	0	0	0	0	
5	0	0	0	0	0	0	0	0	
K 6	0	0	0	0	0	0	0	0	
7	0	0	0	0	0	0	0	0	
8	0	0	0	0	0	0	0	0	
9	0	0	1.6	1.7	1.8	2.0	2.1	2.3	Z _{MIN}

Door clearance at R=1mm

For further explanation → see page 2.14

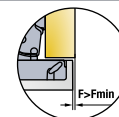

V	20	22	24	26	28	30	32	34	
3	0.6	0.9	1.3	1.7	2.2	4.0	5.9	7.8	
4	0.6	0.9	1.2	1.7	2.2	3.4	5.2	7.1	
5	0.6	0.9	1.2	1.6	2.1	2.9	4.6	6.5	
K 6	0.6	0.9	1.2	1.5	2.1	2.6	4.1	5.9	
7	0.6	0.9	1.2	1.5	2.1	2.6	3.6	5.3	
8	0.6	0.8	1.2	1.5	2.0	2.5	3.2	4.8	
9	0.6	0.8	1.2	1.5	2.0	2.5	3.1	4.4	F _{MIN}

T-type-i 95 Thick Door Hinge

For wood doors

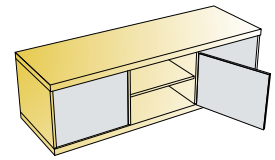
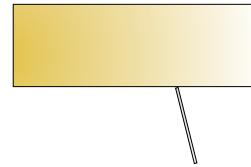
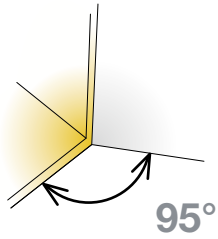

- Opening angle
- Drilling diameter for hinge cup
- Drilling depth
- Hinge on plate mounting system

95°
35mm
12mm
3Way snap-on



Technical details

Cup type	Interaxis 45mm	Interaxis 48mm
Item number	708-0ZT0-054	708-0ZS0-054
EasyFix	708-0ZT1-054	708-0ZS1-054
	708-0ZT4-054	708-0ZS4-054

Drilling patterns for hinge cups → see page 2.17

Cranking
9mm

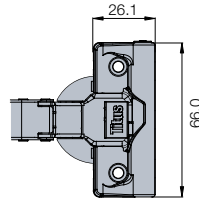
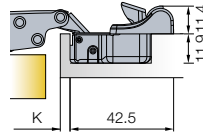
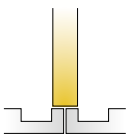

150 Pcs

Made of steel

Cranking
17mm

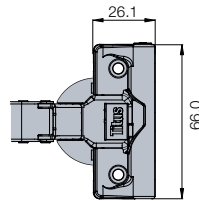
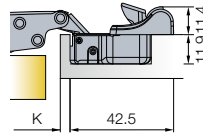
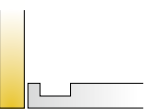

150 Pcs

Made of steel

708-0WT0-054	708-0WS0-054
708-0WT1-054	708-0WS1-054
708-0WT4-054	708-0WS4-054

Drilling patterns for hinge cups → see page 2.17

Mounting plates



Cam adjustable cruciform mounting plate
→ see page 2.81



Cruciform mounting plate
→ see page 2.83



Cam adjustable linear mounting plate
→ see page 2.81



Face frame adapter plate
→ see page 2.83

Hinge cup screws If not pre-mounted

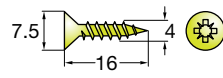

820-6328-050

10000 Pcs

Accessories



Cover caps for hinge arm
→ see page 2.177

Legend of hinge cup symbols

Screw-on ready
← screws

Machine insertion ready

EasyFix system

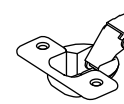

Touch opening

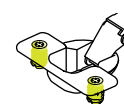

PushOpen Solutions
→ see pages 2.199-2.204

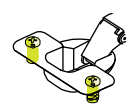

Damping adjustment

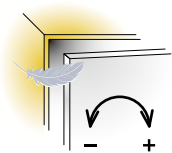

Door adjustment

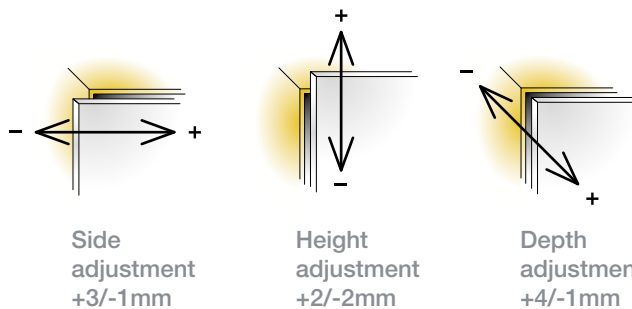

Side adjustment
+3/-1mm

Height adjustment
+2/-2mm

Depth adjustment
+4/-1mm

For further explanation → see page 2.25

For further explanation → see pages 2.22-2.24

Mounting details

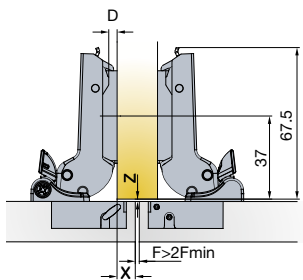
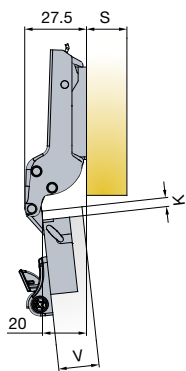

Mounting plate drilling distance

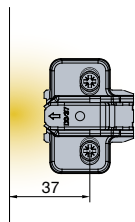

Mounting plate thickness table

For further explanation → see page 2.13

X	4	5	6	7	8	9	10	11	12	13
3	3	2	1	0						
4	4	3	2	1	0					
5		4	3	2	1	0				
K 6			4	3	2	1	0			
7				4	3	2	1	0		
8					4	3	2	1	0	
9						4	3	2	1	0

$D=4+K-X$

Drawings show application on D=0mm mounting plate

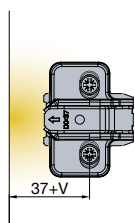
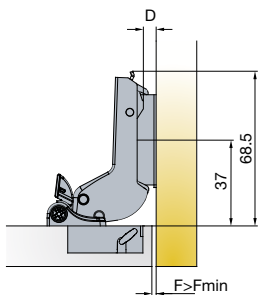
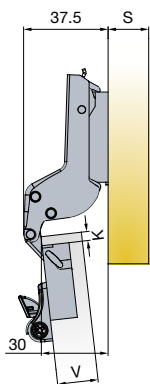

V	20	22	24	26	28	30	32
3	0	0	1	1	2	3	4*
4	1	1	2	2	3	4	4*
K 5	2	2	3	3	4	4	4*
6	3	3	4	4	4*	4*	
7	4	4	4*	4*	4*	4*	

$D=-4+K+F$

*Hinge adjustment needed

Drawings show application on D=2mm mounting plate

Gap Z

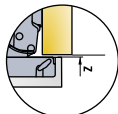

V	20	22	24	26	28	30	32	34
3	0	0	0	0	0	0	0	0
4	0	0	0	0	0	0	0	0
5	0	0	0	0	0	0	0	0
K 6	0	0	0	0	0	0	0	0
7	0	0	0	0	0	0	0	0
8	0	0	0	0	0	0	0	0
9	0	0	1.6	1.7	1.8	2.0	2.1	2.3

Z_{MIN}

Door clearance at R=1mm

For further explanation → see page 2.14

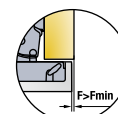

V	20	22	24	26	28	30	32	34
3	0.6	0.9	1.3	1.7	2.2	4.0	5.9	7.8
4	0.6	0.9	1.2	1.7	2.2	3.4	5.2	7.1
5	0.6	0.9	1.2	1.6	2.1	2.9	4.6	6.5
K 6	0.6	0.9	1.2	1.5	2.1	2.6	4.1	5.9
7	0.6	0.9	1.2	1.5	2.1	2.6	3.6	5.3
8	0.6	0.8	1.2	1.5	2.0	2.5	3.2	4.8
9	0.6	0.8	1.2	1.5	2.0	2.5	3.1	4.4

F_{MIN}

T-type 110

For wood doors

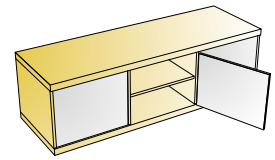
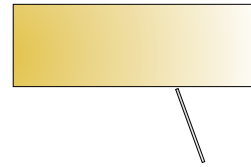
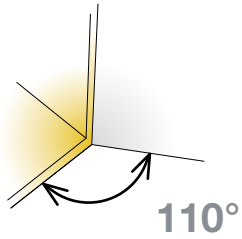

- Opening angle
- Drilling diameter for hinge cup
- Drilling depth
- Hinge on plate mounting system

110°
35mm
12mm
3Way snap-on



Technical details

Cup type	Interaxis 45mm	Interaxis 48mm
Item number		

Cranking
0mm

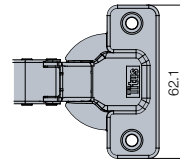
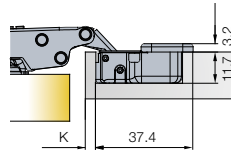
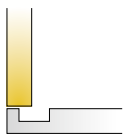

	702-0AK0-054	702-0AL0-054
	702-0AK1-054	702-0AL1-054
	702-0AK4-054	702-0AL4-054

Drilling patterns for hinge cups → see page 2.17

150 Pcs

Made of steel

Cranking
5mm

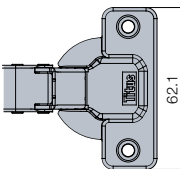
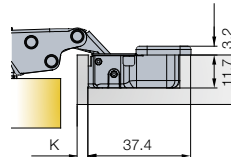
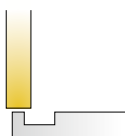

	702-0BK0-054	702-0BL0-054
	702-0BK1-054	702-0BL1-054
	702-0BK4-054	702-0BL4-054

Drilling patterns for hinge cups → see page 2.17

150 Pcs

Made of steel

Mounting plates



Cam adjustable cruciform mounting plate
→ see page 2.81



Cruciform mounting plate
→ see page 2.83



Cam adjustable linear mounting plate
→ see page 2.81



Face frame adapter plate
→ see page 2.83

Hinge cup screws

If not pre-mounted

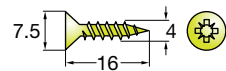

820-6328-050

10000 Pcs

Accessories



Cover caps for hinge arm
→ see page 2.177



Hinge angle restrictor
→ see page 2.175

Legend of hinge cup symbols

Screw-on ready
← screws

Machine insertion ready

EasyFix system

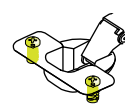
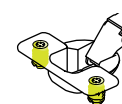
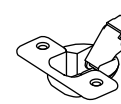

Door adjustment

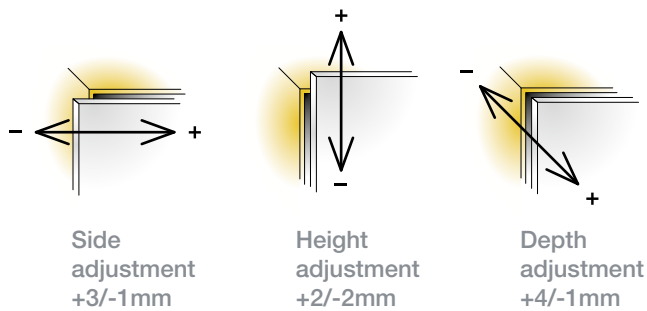

For further explanation → see pages 2.22-2.24

Mounting details

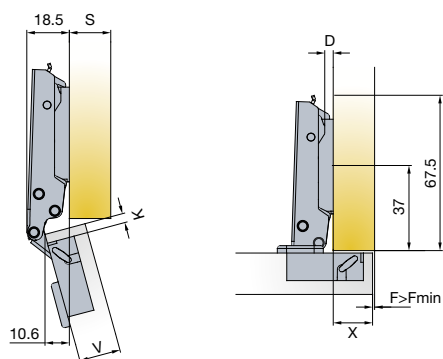

Drawings show application on D=0mm mounting plate

Mounting plate drilling distance

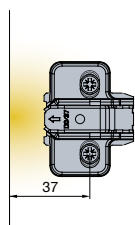

Mounting plate thickness table

For further explanation → see page 2.13

X	13	14	15	16	17	18	19
3	3	2	1	0			
4	4	3	2	1	0		
K							
5		4	3	2	1	0	
6			4	3	2	1	0
							D

$D=13+K-X$

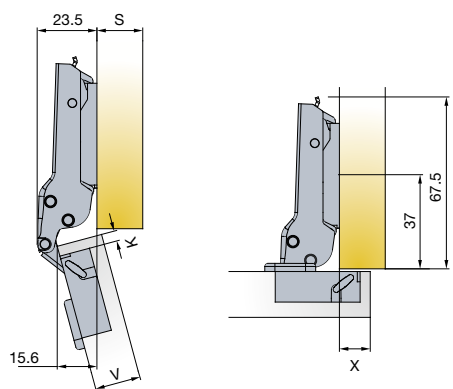

Drawings show application on D=0mm mounting plate

x	8	9	10	11	12	13	14
3	3	2	1	0			
4	4	3	2	1	0		
K							
5		4	3	2	1	0	
6			4	3	2	1	0
							D

$D=8+K-X$

Soft closing systems



Glissando TT
→ see page 2.189



Glissando CR
→ see page 2.195

Touch opening



PushOpen Solutions
→ see pages 2.199-2.204

Door clearance at R=1mm

For further explanation → see page 2.14

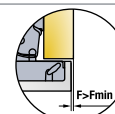

V	16	17	18	19	20	21	22	23	24	25	26
3	0.5	0.7	0.8	1	1.2	1.5	1.7	2.1	2.8	4.1	5.5
4	0.4	0.7	0.8	1	1.2	1.5	1.7	2.1	2.3	3.1	4.5
K											
5	0.4	0.6	0.7	0.9	1.1	1.4	1.6	2	2.2	2.6	3.5
6	0.4	0.6	0.7	0.9	1.1	1.4	1.6	2	2.2	2.6	2.9
											F _{MIN}

Gap Z_{MIN}=0

T-type 110

For wood doors

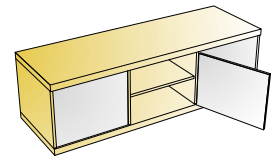
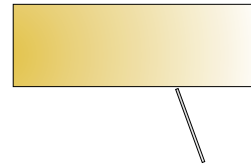
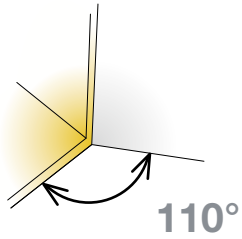

- Opening angle
- Drilling diameter for hinge cup
- Drilling depth
- Hinge on plate mounting system

110°
35mm
12mm
3Way snap-on



Technical details

Cup type	Interaxis 45mm	Interaxis 48mm
Item number		

Cranking

9mm

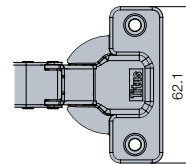
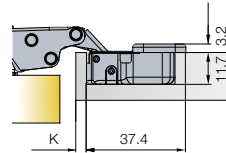
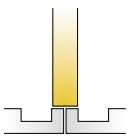

	702-0CK0-054	702-0CL0-054
	702-0CK1-054	702-0CL1-054
	702-0CK4-054	702-0CL4-054

Drilling patterns for hinge cups → see page 2.17

150 Pcs

Made of steel

Cranking

17mm

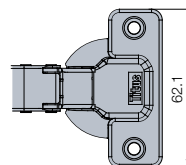
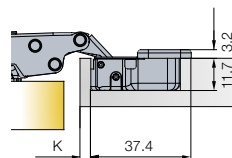
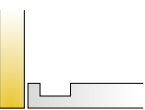

	702-0DK0-054	702-0DL0-054
	702-0DK1-054	702-0DL1-054
	702-0DK4-054	702-0DL4-054

Drilling patterns for hinge cups → see page 2.17

150 Pcs

Made of steel

Mounting plates

Cam adjustable cruciform mounting plate
→ see page 2.81

Cruciform mounting plate
→ see page 2.83

Cam adjustable linear mounting plate
→ see page 2.81

Face frame adapter plate
→ see page 2.83

Hinge cup screws

If not pre-mounted

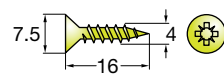

820-6328-050

10000 Pcs

Accessories

Cover caps for hinge arm
→ see page 2.177

Hinge angle restrictor
→ see page 2.175

Legend of hinge cup symbols

Screw-on ready
← screws

Machine insertion ready

EasyFix system

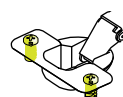
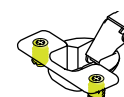

Door adjustment

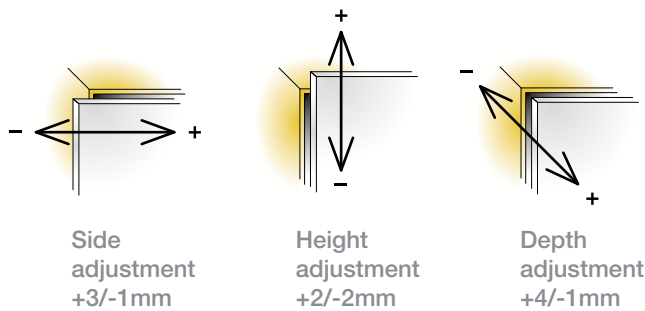

For further explanation → see pages 2.22-2.24

Mounting details

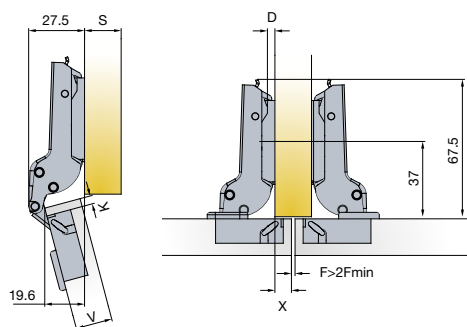

Drawings show application on D=0mm mounting plate

Mounting plate drilling distance

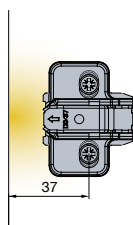

Mounting plate thickness table

For further explanation → see page 2.13

X	4	5	6	7	8	9	10
3	3	2	1	0			
4	4	3	2	1	0		
K							
5		4	3	2	1	0	
6			4	3	2	1	0
							D

$D=4+K-X$

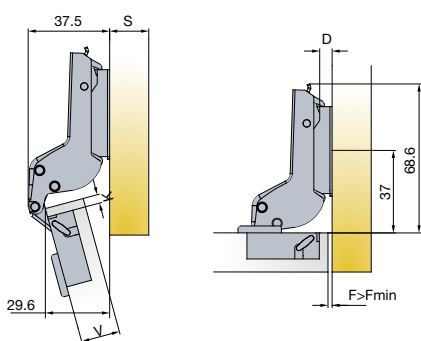

Drawings show application on D=2mm mounting plate

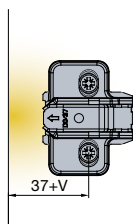

V	16	17	18	19	20	21	22	23	24
3	0	0	0	0	1	1	1	1	2
4	1	1	1	1	2	2	2	2	3
K									
5	2	2	2	2	3	3	3	3	4
6	3	3	3	3	4	4	4	4	
									D

$D=-4+K+F$

Soft closing systems



Glissando TT
→ see page 2.189



Glissando CR
→ see page 2.195

Touch opening



PushOpen Solutions
→ see pages 2.199-2.204

Door clearance at R=1mm

For further explanation → see page 2.14

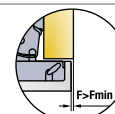

V	16	17	18	19	20	21	22	23	24	25	26
3	0.5	0.7	0.8	1	1.2	1.5	1.7	2.1	2.8	4.1	5.5
4	0.4	0.7	0.8	1	1.2	1.5	1.7	2.1	2.3	3.1	4.5
K											
5	0.4	0.6	0.7	0.9	1.1	1.4	1.6	2	2.2	2.6	3.5
6	0.4	0.6	0.7	0.9	1.1	1.4	1.6	2	2.2	2.6	2.9
											F _{MIN}

Gap Z_{MIN}=0

T-type 110/15°

15° angled application for wood doors

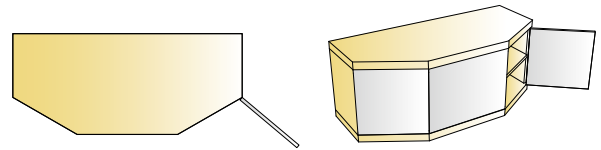
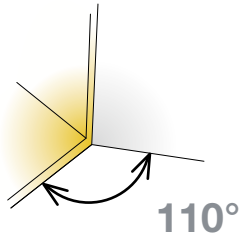

- Opening angle 110°
- Drilling diameter for hinge cup 35mm
- Drilling depth 12mm
- Hinge on plate mounting system 3Way snap-on



Technical details

Cup type	Interaxis 45mm	Interaxis 48mm
Item number	Item number	Item number
	702-0D63-650	702-0D65-650
	702-0D69-650	702-0D71-650
	702-0D75-650	702-0D77-650

Cranking
9mm

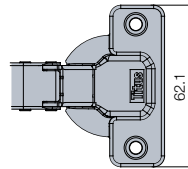
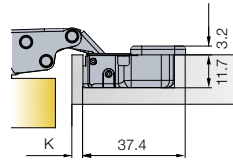
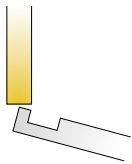

Drilling patterns for hinge cups → see page 2.17

100 Pcs

Cup made of steel, arm made of zinc

Mounting plates



Cam adjustable cruciform mounting plate
→ see page 2.81



Cruciform mounting plate
→ see page 2.83



Cam adjustable linear mounting plate
→ see page 2.81



Face frame adapter plate
→ see page 2.83

Hinge cup screws

If not pre-mounted

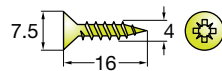

820-6328-050

10000 Pcs

Accessories



Cover caps for hinge arm
→ see page 2.177



Hinge angle restrictor
→ see page 2.175

Legend of hinge cup symbols



Screw-on ready
← screws



Machine insertion ready



EasyFix system

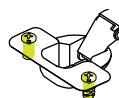
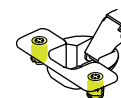

Door adjustment

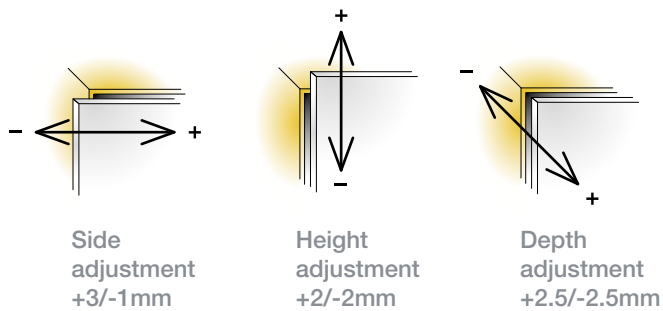

For further explanation → see pages 2.22-2.24

Mounting details

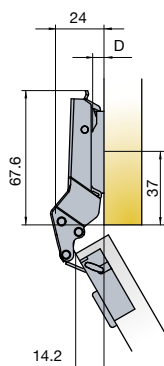

Drawings show application on D=0mm mounting plate

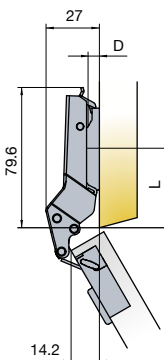

Drawings show application on D=0mm mounting plate

Mounting plate drilling distance

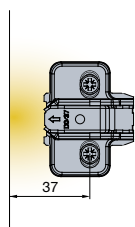
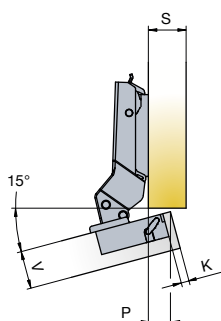

Mounting plate thickness table
For further explanation → see page 2.13

P	11	12	13	14	15	19	17	18
3	4	3	2	1	0			
4		4	3	2	1	0		
5			4	3	2	1	0	
6				4	3	2	1	0 D

L=40 for thickness D=0
L=40 for thickness D=1
L=39 for thickness D=2
L=39 for thickness D=3
L=38 for thickness D=4

X	6	7	8	9	10	11	12	13
3	4	3	2	1	0			
4		4	3	2	1	0		
5			4	3	2	1	0	
6				4	3	2	1	0 D

Soft closing system



Glissando TT
→ see page 2.189

Touch opening



PushOpen Solutions
→ see pages 2.199-2.204

Door clearance at R=1mm

For further explanation → see page 2.14

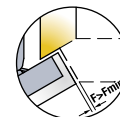

V	16	17	18	19	20	21	22	23	24	25	26
3	0.5	0.7	0.8	1	1.2	1.5	1.7	2.1	2.8	4.1	5.5
4	0.4	0.7	0.8	1	1.2	1.5	1.7	2.1	2.3	3.1	4.5
5	0.4	0.6	0.7	0.9	1.1	1.4	1.6	2	2.2	2.6	3.5
6	0.4	0.6	0.7	0.9	1.1	1.4	1.6	2	2.2	2.6	2.9 F _{MIN}

Gap Z_{MIN}=0

T-type 110/30°

30° angled application for wood doors

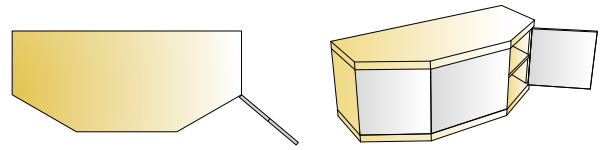
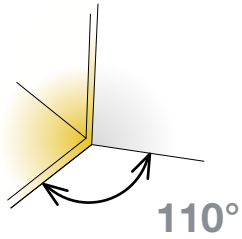

- Opening angle 110°
- Drilling diameter for hinge cup 35mm
- Drilling depth 12mm
- Hinge on plate mounting system 3Way snap-on



Technical details

Cup type	Interaxis 45mm	Interaxis 48mm
Item number	Item number	Item number
	702-0E51-650	702-0E53-650
	702-0E57-650	702-0E59-650
	702-0E63-650	702-0E65-650

Cranking
9mm

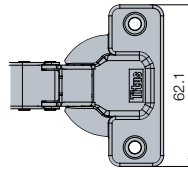
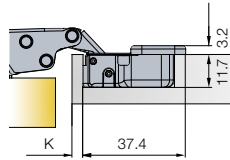
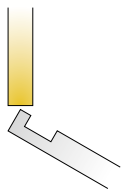

Drilling patterns for hinge cups → see page 2.17

100 Pcs

Cup made of steel, arm made of zinc

Mounting plates



Cam adjustable cruciform mounting plate
→ see page 2.81



Cruciform mounting plate
→ see page 2.83



Cam adjustable linear mounting plate
→ see page 2.81



Face frame adapter plate
→ see page 2.83

Hinge cup screws
If not pre-mounted

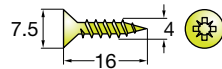

820-6328-050

10000 Pcs

Accessories



Cover caps for hinge arm
→ see page 2.177



Hinge angle restrictor
→ see page 2.175

Legend of hinge cup symbols

Screw-on ready
← screws

Machine insertion ready

EasyFix system

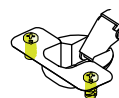
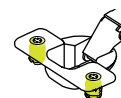
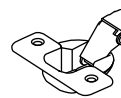

Door adjustment

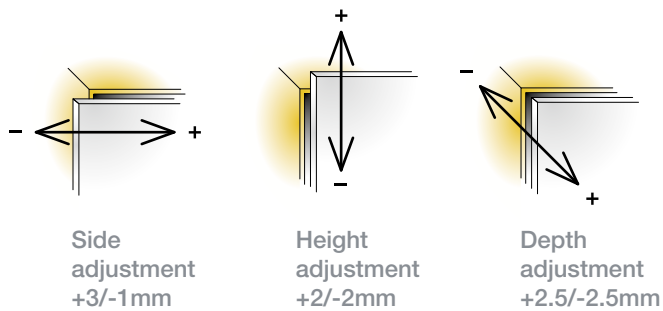

For further explanation → see pages 2.22-2.24

Mounting details

Mounting plate drilling distance

Mounting plate thickness table
For further explanation → see page 2.13

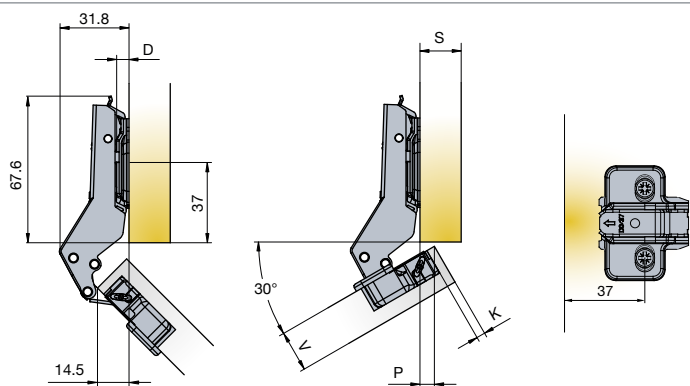

Drawings show application on D=0mm mounting plate

P	1.5	2.5	3.5	4.5	5.5	6.5	7.5	8.5
3	4	3	2	1	0			
4		4	3	2	1	0		
5			4	3	2	1	0	
6				4	3	2	1	0

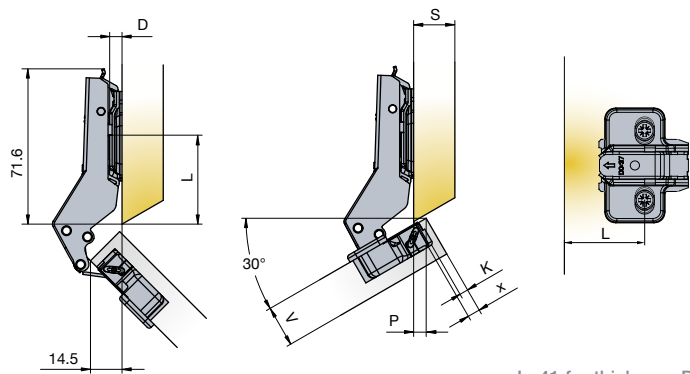

Drawings show application on D=0mm mounting plate

P	2	3	4	5	6	7	8	9
3	4	3	2	1	0			
4		4	3	2	1	0		
5			4	3	2	1	0	
6				4	3	2	1	0

L=41 for thickness D=0
L=41 for thickness D=1
L=40 for thickness D=2
L=40 for thickness D=3
L=39 for thickness D=4

Soft closing system



Glissando TT
→ see page 2.189

Touch opening



PushOpen Solutions
→ see pages 2.199-2.204

Door clearance at R=1mm

For further explanation → see page 2.14

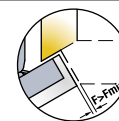

V	16	17	18	19	20	21	22	23	24	25	26
3	0.5	0.7	0.8	1	1.2	1.5	1.7	2.1	2.8	4.1	5.5
4	0.4	0.7	0.8	1	1.2	1.5	1.7	2.1	2.3	3.1	4.5
5	0.4	0.6	0.7	0.9	1.1	1.4	1.6	2	2.2	2.6	3.5
6	0.4	0.6	0.7	0.9	1.1	1.4	1.6	2	2.2	2.6	2.9

Gap Z_{MIN}=0

T-type 110/45°

45° angled application for wood doors

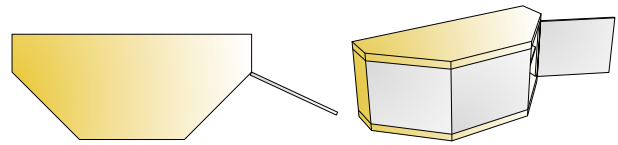
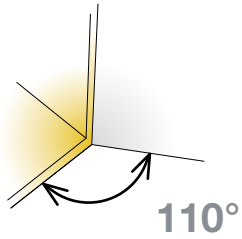

- Opening angle 110°
- Drilling diameter for hinge cup 35mm
- Drilling depth 12mm
- Hinge on plate mounting system 3Way snap-on



Technical details

Cup type	Interaxis 45mm	Interaxis 48mm
Item number	Item number	Item number
	702-0D81-650	702-0D83-650
	702-0D87-650	702-0D89-650
	702-0D97-650	702-0E18-650

Drilling patterns for hinge cups → see page 2.17

Cranking
9mm

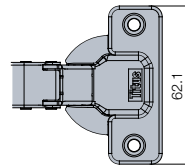
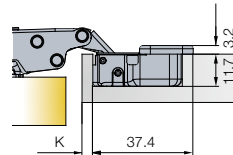
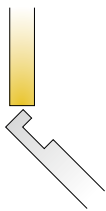

100 Pcs

Cup made of steel, arm made of zinc

Mounting plates

- Cam adjustable cruciform mounting plate → see page 2.81
- Cruciform mounting plate → see page 2.83
- Cam adjustable linear mounting plate → see page 2.81
- Face frame adapter plate → see page 2.83

Hinge cup screws
If not pre-mounted

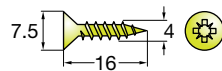

820-6328-050

10000 Pcs

Accessories

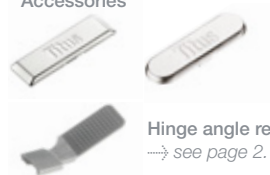

Cover caps for hinge arm → see page 2.177

Hinge angle restrictor → see page 2.175

Legend of hinge cup symbols

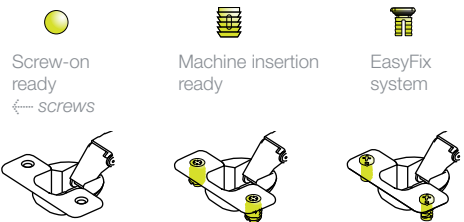

Door adjustment

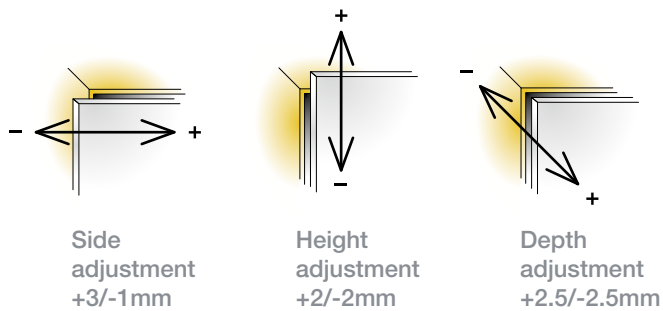

For further explanation → see pages 2.22-2.24

Mounting details

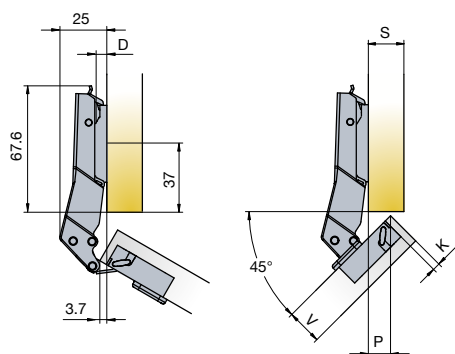

Drawings show application on D=0mm mounting plate

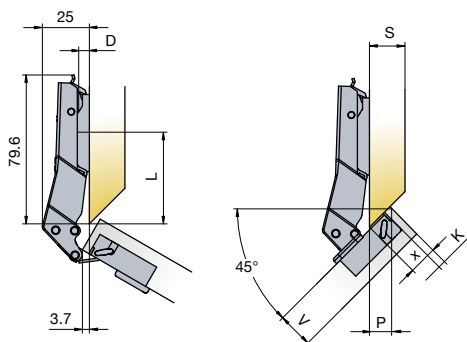

Drawings show application on D=0mm mounting plate

Mounting plate drilling distance

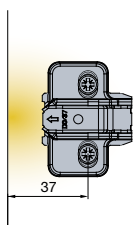

Mounting plate thickness table

For further explanation → see page 2.13

P	7	7.5	8	8.5	9	9.5	10	10.5	11	11.5	12	12.5	13	13.5
3	4		3		2		1		0					
4			4		3		2		1		0			
5				4	3		2		1		0			
6						4	3		2		1		0	

X	10	11	12	13	14	15	16	17
3	4	3	2	1	0			
4		4	3	2	1	0		
5			4	3	2	1	0	
6				4	3	2	1	0 D

L=49 for thickness D=0
 L=48 for thickness D=1
 L=47 for thickness D=2
 L=46 for thickness D=3
 L=45 for thickness D=4

Soft closing system



Glissando TT
 → see page 2.189

Touch opening



PushOpen Solutions
 → see pages 2.199-2.204

Door clearance at R=1mm

For further explanation → see page 2.14

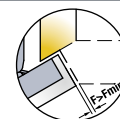

V	16	17	18	19	20	21	22	23	24	25	26
3	0.5	0.7	0.8	1	1.2	1.5	1.7	2.1	2.8	4.1	5.5
4	0.4	0.7	0.8	1	1.2	1.5	1.7	2.1	2.3	3.1	4.5
5	0.4	0.6	0.7	0.9	1.1	1.4	1.6	2	2.2	2.6	3.5
6	0.4	0.6	0.7	0.9	1.1	1.4	1.6	2	2.2	2.6	2.9 F _{MIN}

Gap Z_{MIN}=0

T-type 110/45°

45° angled application for wood doors

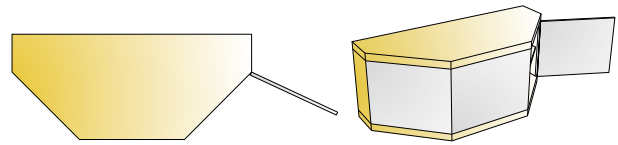
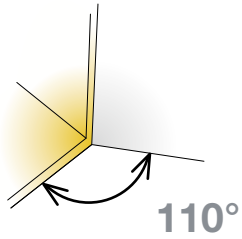

- Opening angle 110°
- Drilling diameter for hinge cup 35mm
- Drilling depth 12mm
- Hinge on plate mounting system 3Way snap-on



Technical details

Cup type	Interaxis 45mm	Interaxis 48mm
Item number	Item number	Item number
	702-0B07-650	702-0B09-650
	702-0C77-650	702-0C79-650
	702-0C53-650	702-0C55-650

Cranking
17mm

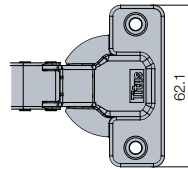
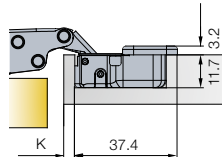
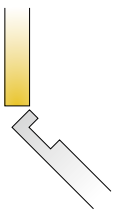

Drilling patterns for hinge cups → see page 2.17

100 Pcs

Cup made of steel, arm made of zinc

Mounting plates

- Cam adjustable cruciform mounting plate
→ see page 2.81
- Cruciform mounting plate
→ see page 2.83
- Cam adjustable linear mounting plate
→ see page 2.81
- Face frame adapter plate
→ see page 2.83

Hinge cup screws

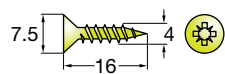

820-6328-050

10000 Pcs

Accessories

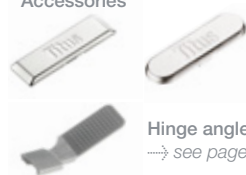

Cover caps for hinge arm
→ see page 2.177

Hinge angle restrictor
→ see page 2.175

Legend of hinge cup symbols

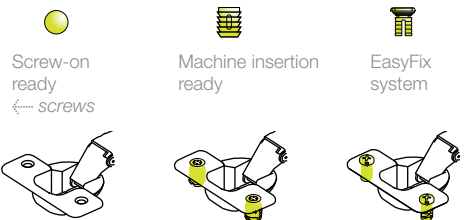

Door adjustment

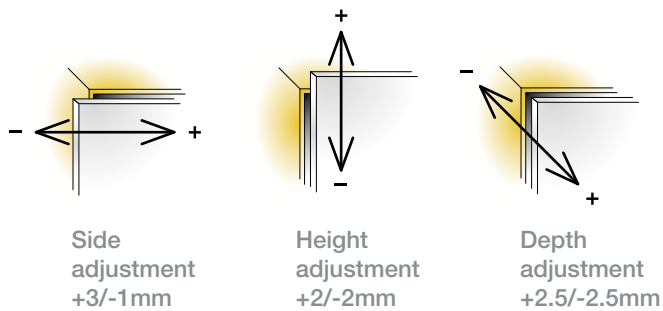

For further explanation → see pages 2.22-2.24

Mounting details

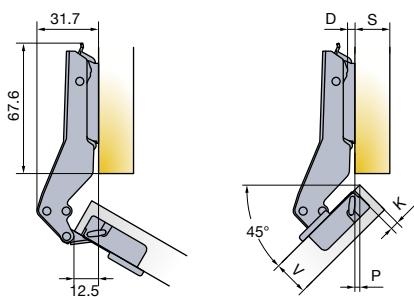

Drawings show application on D=0mm mounting plate

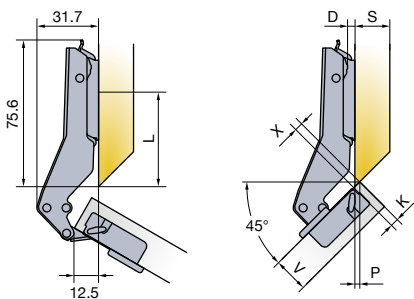

Drawings show application on D=0mm mounting plate

Mounting plate drilling distance

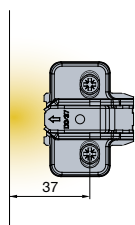

Mounting plate thickness table
For further explanation → see page 2.13

P	0	0.5	1	1.5	2	2.5	3	3.5	4
3		2		1		0			
4	3		2		1		0		
5		3		2		1		0	
6	4		3		2		1		0

X 0 0.5 1 1.5 2 2.5 3 3.5 4 4.5 5 6

3	2		1			0					
4		2			1			0			
5		3			2		1			0	
6	4		3			2		1			0

L=45 for thickness D=0
L=44 for thickness D=1
L=43 for thickness D=2
L=42 for thickness D=3
L=41 for thickness D=4

Soft closing system



Glissando TT
→ see page 2.189

Touch opening



PushOpen Solutions
→ see pages 2.199-2.204

Door clearance at R=1mm

For further explanation → see page 2.14

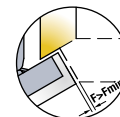

V	16	17	18	19	20	21	22	23	24	25	26
3	0.5	0.7	0.8	1	1.2	1.5	1.7	2.1	2.8	4.1	5.5
4	0.4	0.7	0.8	1	1.2	1.5	1.7	2.1	2.3	3.1	4.5
5	0.4	0.6	0.7	0.9	1.1	1.4	1.6	2	2.2	2.6	3.5
6	0.4	0.6	0.7	0.9	1.1	1.4	1.6	2	2.2	2.6	2.9

Gap Z_{MIN}=0

T-type 110/90°

For wood door cabinets with blind panels

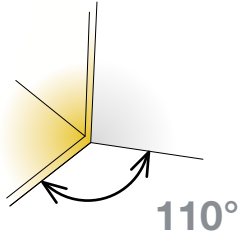
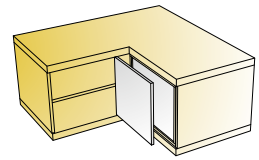

- Opening angle 110°
- Drilling diameter for hinge cup 35mm
- Drilling depth 12mm
- Hinge on plate mounting system 3Way snap-on



Technical details

Cup type	Interaxis 45mm	Interaxis 48mm
Item number	Item number	Item number
	702-0A95-650	702-0A97-650
	702-0D35-650	702-0D37-650
	702-0D29-650	702-0D31-650

Cranking
17mm

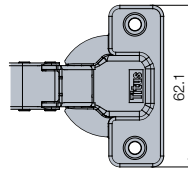
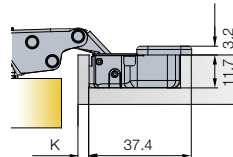
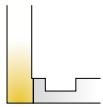

Drilling patterns for hinge cups → see page 2.17

100 Pcs

Cup made of steel, arm made of zinc

Mounting plates



Cam adjustable cruciform mounting plate
→ see page 2.81



Cruciform mounting plate
→ see page 2.83



Cam adjustable linear mounting plate
→ see page 2.81



Face frame adapter plate
→ see page 2.83

Hinge cup screws If not pre-mounted

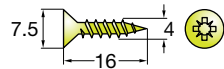

820-6328-050

10000 Pcs

Accessories



Cover caps for hinge arm
→ see page 2.177



Hinge angle restrictor
→ see page 2.175

Legend of hinge cup symbols



Screw-on ready
← screws



Machine insertion ready



EasyFix system

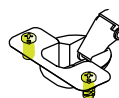
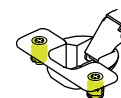

Door adjustment

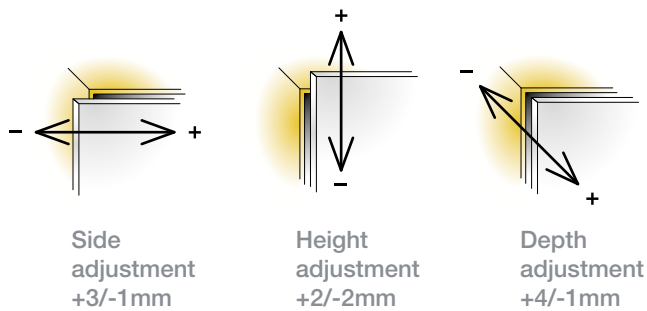

For further explanation → see pages 2.22-2.24

Mounting details

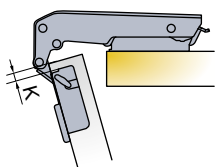

Drawing shows application on D=2mm mounting plate

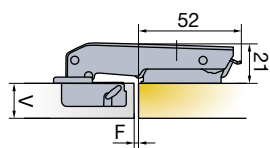

Drawing shows application on D=2mm mounting plate

Mounting plate drilling distance

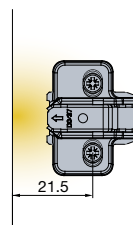

Soft closing system



Glissando TT
→ see page 2.189

Touch opening



PushOpen Solutions
→ see pages 2.199-2.204

Door clearance at R=1mm

For further explanation → see page 2.14

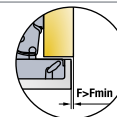

V	16	17	18	19	20	21	22	23	24	25	26
3	0.5	0.7	0.8	1	1.2	1.5	1.7	2.1	2.8	4.1	5.5
4	0.4	0.7	0.8	1	1.2	1.5	1.7	2.1	2.3	3.1	4.5
K											
5	0.4	0.6	0.7	0.9	1.1	1.4	1.6	2	2.2	2.6	3.5
6	0.4	0.6	0.7	0.9	1.1	1.4	1.6	2	2.2	2.6	2.9 F _{MIN}

Gap Z_{MIN}=0

T-type 120

For wood doors

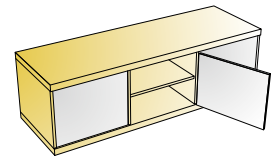
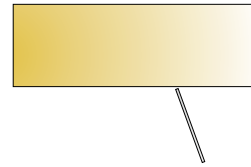
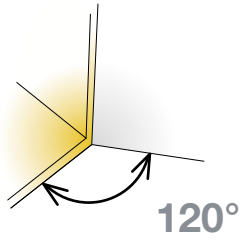

- Opening angle
- Drilling diameter for hinge cup
- Drilling depth
- Hinge on plate mounting system

120°
35mm
12mm
3Way snap-on



Technical details

Cup type	Interaxis 45mm	Interaxis 48mm
Item number	Item number	Item number
	702-0UK0-054	702-0UL0-054
	702-0UK1-054	702-0UL1-054
	702-0UK4-054	702-0UL4-054

Cranking

0mm

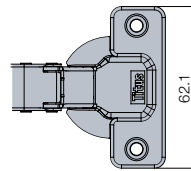
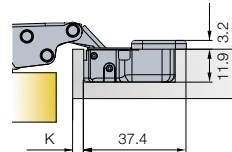
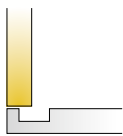

Drilling patterns for hinge cups → see page 2.17

150 Pcs

Made of steel

Mounting plates



Cam adjustable cruciform mounting plate
→ see page 2.81



Cruciform mounting plate
→ see page 2.83



Cam adjustable linear mounting plate
→ see page 2.81



Face frame adapter plate
→ see page 2.83

Hinge cup screws

If not pre-mounted

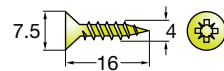

820-6328-050

10000 Pcs

Accessories



Cover caps for hinge arm
→ see page 2.177

Legend of hinge cup symbols



Screw-on ready
← screws



Machine insertion ready



EasyFix system

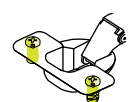
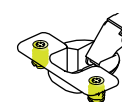
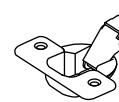

Door adjustment

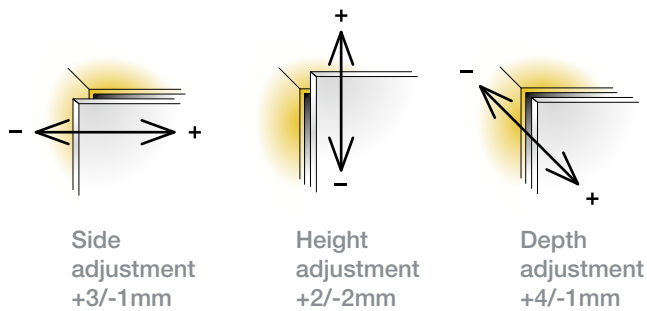

For further explanation → see pages 2.22-2.24

Mounting details

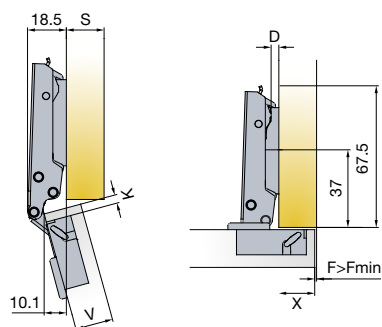

Drawings show application on D=0mm mounting plate

Mounting plate drilling distance

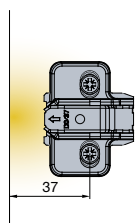

Mounting plate thickness table

For further explanation → see page 2.13

X	13	14	15	16	17	18	19
3	3	2	1	0			
4	4	3	2	1	0		
K		4	3	2	1	0	
6			4	3	2	1	0

$D=13+K-X$

Soft closing systems



Glissando TT
→ see page 2.189



Glissando CR
→ see page 2.195

Touch opening



PushOpen Solutions
→ see pages 2.199-2.204

Door clearance at R=1mm

For further explanation → see page 2.14

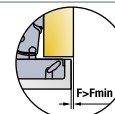

V	16	17	18	19
3	1.1	0.4	0	0
K	2	1.4	0.7	0.1
5	3	2.3	1.6	1

Gap Z_{MIN} =2

T-type 95 Thick Door Hinge

For wood doors

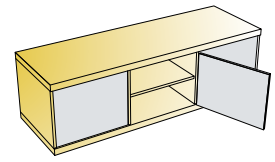
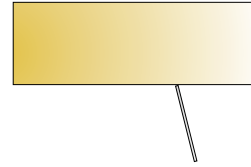
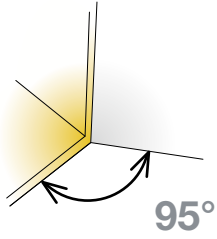

- Opening angle
- Drilling diameter for hinge cup
- Drilling depth
- Hinge on plate mounting system

95°
35mm
12mm
3Way snap-on



Technical details

Cup type	Interaxis 45mm	Interaxis 48mm
	Item number	Item number

Cranking
0mm

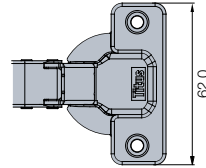
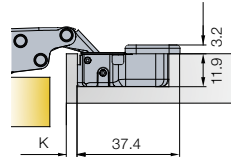
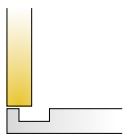

	707-0XK0-054	707-0XL0-054
	707-0XK1-054	707-0XL1-054
	707-0XK4-054	707-0XL4-054

Drilling patterns for hinge cups → see page 2.17

150 Pcs

Made of steel

Cranking
5mm

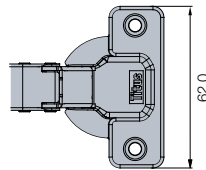
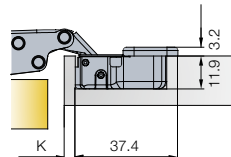
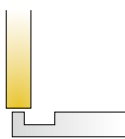

	707-0YK0-054	707-0YL0-054
	707-0YK1-054	707-0YL1-054
	707-0YK4-054	707-0YL4-054

Drilling patterns for hinge cups → see page 2.17

150 Pcs

Made of steel

Mounting plates



Cam adjustable cruciform mounting plate
→ see page 2.81



Cruciform mounting plate
→ see page 2.83



Cam adjustable linear mounting plate
→ see page 2.81



Face frame adapter plate
→ see page 2.83

Hinge cup screws If not pre-mounted

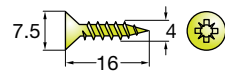

820-6328-050
10000 Pcs

Accessories



Cover caps for hinge arm
→ see page 2.177

Touch opening



PushOpen Solutions
→ see pages 2.199-2.204

Legend of hinge cup symbols

Screw-on ready
← screws

Machine insertion ready

EasyFix system

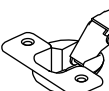

Soft closing systems
Glissando TT



→ see page 2.189



Glissando CR



→ see page 2.195

Door adjustment

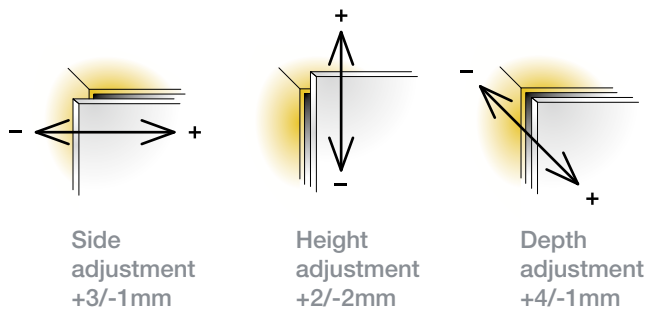

For further explanation → see pages 2.22-2.24

Mounting details

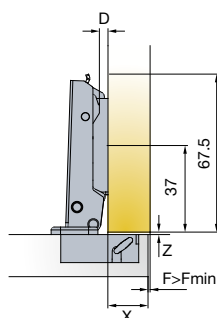
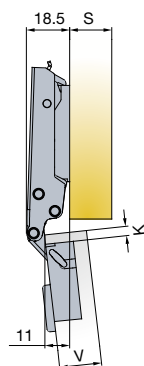

Drawings show application on D=0mm mounting plate

Mounting plate drilling distance

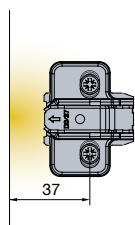

Mounting plate thickness table

For further explanation → see page 2.13

X	13	14	15	16	17	18	19	20	21	22
3	3	2	1	0						
4	4	3	2	1	0					
5		4	3	2	1	0				
K 6			4	3	2	1	0			
7				4	3	2	1	0		
8					4	3	2	1	0	
9						4	3	2	1	0

$D=13+K-X$

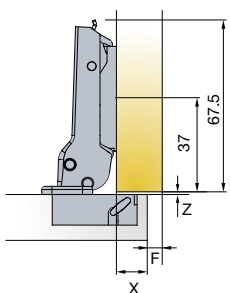
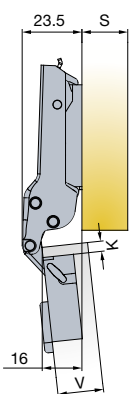

Drawings show application on D=0mm mounting plate

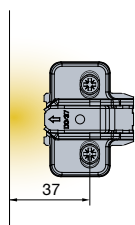

X	8	9	10	11	12	13	14	15	16	17
3	3	2	1	0						
4	4	3	2	1	0					
5		4	3	2	1	0				
K 6			4	3	2	1	0			
7				4	3	2	1	0		
8					4	3	2	1	0	
9						4	3	2	1	0

$D=8+K-X$

Gap Z

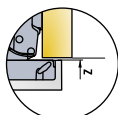

V	20	22	24	26	28	30	32	34	
3	0	0	0	0	0	0	0	0	
4	0	0	0	0	0	0	0	0	
5	0	0	0	0	0	0	0	0	
K 6	0	0	0	0	0	0	0	0	
7	0	0	0	0	0	0	0	0	
8	0	0	0	0	0	0	0	0	
9	0	0	1.6	1.7	1.8	2.0	2.1	2.3	Z _{MIN}

Door clearance at R=1mm

For further explanation → see page 2.14

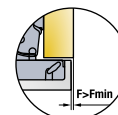

V	20	22	24	26	28	30	32	34	
3	0.6	0.9	1.3	1.7	2.2	4.0	5.9	7.8	
4	0.6	0.9	1.2	1.7	2.2	3.4	5.2	7.1	
5	0.6	0.9	1.2	1.6	2.1	2.9	4.6	6.5	
K 6	0.6	0.9	1.2	1.5	2.1	2.6	4.1	5.9	
7	0.6	0.9	1.2	1.5	2.1	2.6	3.6	5.3	
8	0.6	0.8	1.2	1.5	2.0	2.5	3.2	4.8	
9	0.6	0.8	1.2	1.5	2.0	2.5	3.1	4.4	F _{MIN}

T-type 95 Thick Door Hinge

For wood doors

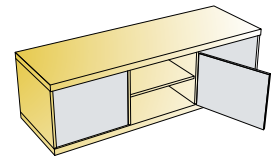
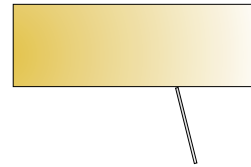
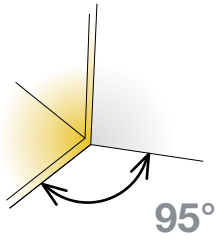

- Opening angle
- Drilling diameter for hinge cup
- Drilling depth
- Hinge on plate mounting system

95°
35mm
12mm
3Way snap-on



Technical details

Cup type	Interaxis 45mm	Interaxis 48mm
	Item number	Item number

Cranking
9mm

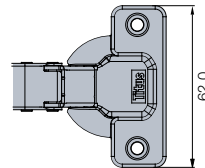
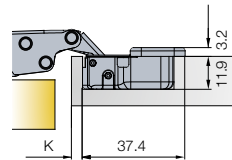
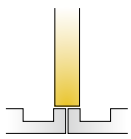

	707-0ZK0-054	707-0ZL0-054
	707-0ZK1-054	707-0ZL1-054
	707-0ZK4-054	707-0ZL4-054

Drilling patterns for hinge cups → see page 2.17

150 Pcs

Made of steel

Cranking
17mm

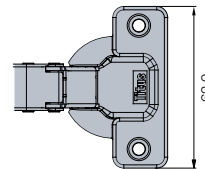
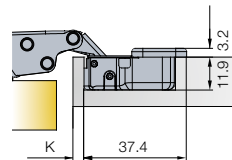
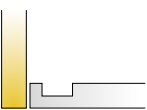

	707-0WK0-054	707-0WL0-054
	707-0WK1-054	707-0WL1-054
	707-0WK4-054	707-0WL4-054

Drilling patterns for hinge cups → see page 2.17

150 Pcs

Made of steel

Mounting plates



Cam adjustable cruciform mounting plate
→ see page 2.81



Cruciform mounting plate
→ see page 2.83



Cam adjustable linear mounting plate
→ see page 2.81



Face frame adapter plate
→ see page 2.83

Hinge cup screws

If not pre-mounted

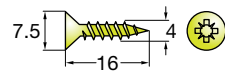

820-6328-050
 10000 Pcs

Accessories



Cover caps for hinge arm
→ see page 2.177

Touch opening



PushOpen Solutions
→ see pages 2.199-2.204

Legend of hinge cup symbols

Screw-on ready
← screws

Machine insertion ready

EasyFix system

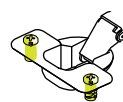
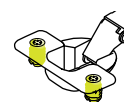
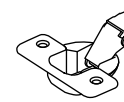

Soft closing systems

Glissando TT



→ see page 2.189

Glissando CR



→ see page 2.195

Door adjustment

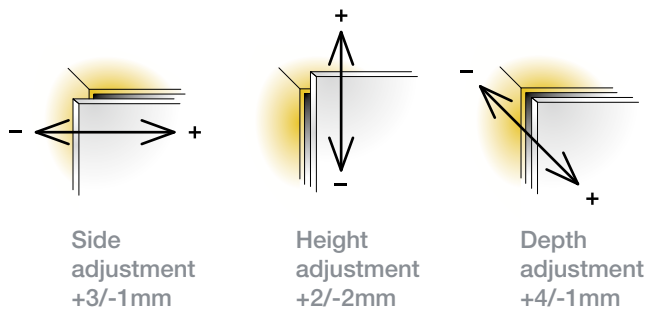

For further explanation → see pages 2.22-2.24

Mounting details

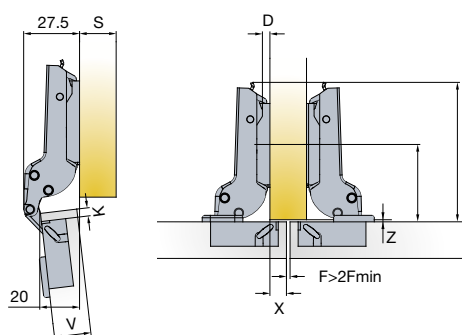

Drawings show application on D=0mm mounting plate

Mounting plate drilling distance

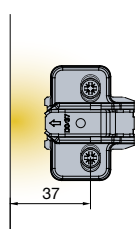

Mounting plate thickness table

For further explanation → see page 2.13

X	4	5	6	7	8	9	10	11	12	13
3	3	2	1	0						
4	4	3	2	1	0					
5		4	3	2	1	0				
K 6			4	3	2	1	0			
7				4	3	2	1	0		
8					4	3	2	1	0	
9						4	3	2	1	0

$D=4+K-X$

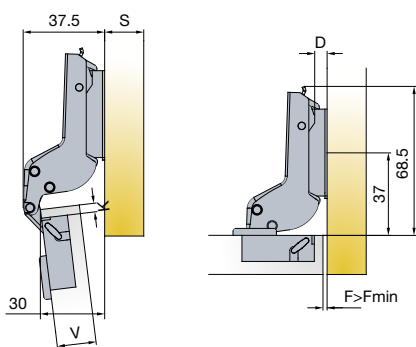

Drawings show application on D=2mm mounting plate

V	20	22	24	26	28	30	32
3	0	0	1	1	2	3	4*
4	1	1	2	2	3	4	4*
K 5	2	2	3	3	4	4	4*
6	3	3	4	4	4*	4*	
7	4	4	4*	4*	4*	4*	

$D=-4+K+F$

*Hinge adjustment needed

Gap Z

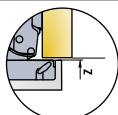

V	20	22	24	26	28	30	32	34
3	0	0	0	0	0	0	0	0
4	0	0	0	0	0	0	0	0
5	0	0	0	0	0	0	0	0
K 6	0	0	0	0	0	0	0	0
7	0	0	0	0	0	0	0	0
8	0	0	0	0	0	0	0	0
9	0	0	1.6	1.7	1.8	2.0	2.1	2.3

Z_{MIN}

Door clearance at R=1mm

For further explanation → see page 2.14

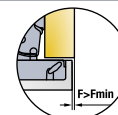

V	20	22	24	26	28	30	32	34
3	0.6	0.9	1.3	1.7	2.2	4.0	5.9	7.8
4	0.6	0.9	1.2	1.7	2.2	3.4	5.2	7.1
5	0.6	0.9	1.2	1.6	2.1	2.9	4.6	6.5
K 6	0.6	0.9	1.2	1.5	2.1	2.6	4.1	5.9
7	0.6	0.9	1.2	1.5	2.1	2.6	3.6	5.3
8	0.6	0.8	1.2	1.5	2.0	2.5	3.2	4.8
9	0.6	0.8	1.2	1.5	2.0	2.5	3.1	4.4

F_{MIN}

T-type 110 Unsprung Hinge

For wood doors

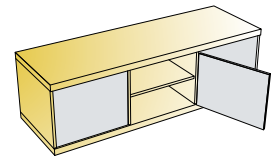
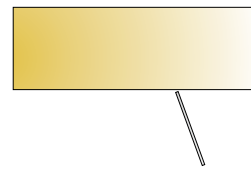
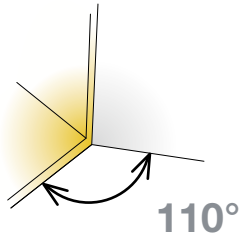

- Opening angle
- Drilling diameter for hinge cup
- Drilling depth
- Hinge on plate mounting system

110°
35mm
12mm
3Way snap-on



Technical details

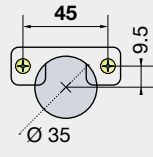
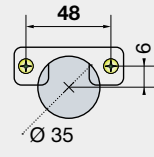

	Interaxis 45mm	Interaxis 48mm
Cup type	 Ø 35	 Ø 35
Item number	704-0593-054	704-0672-054
Item number		704-0553-054

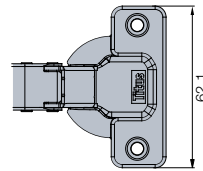
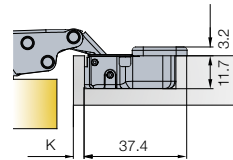
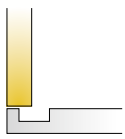
Cranking
0mm



150 Pcs

Made of steel

	704-0593-054	704-0672-054
		704-0553-054

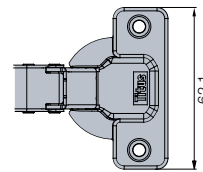
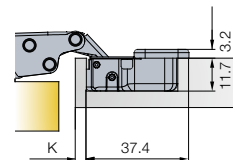
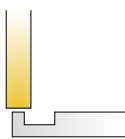

Drilling patterns for hinge cups → see page 2.17

Cranking
5mm



150 Pcs

Made of steel

	704-0661-054	704-0673-054
		704-0604-054

Drilling patterns for hinge cups → see page 2.17

Mounting plates



Cam adjustable cruciform mounting plate
→ see page 2.81



Cruciform mounting plate
→ see page 2.83



Cam adjustable linear mounting plate
→ see page 2.81



Face frame adapter plate
→ see page 2.83

Hinge cup screws

If not pre-mounted

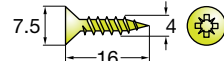

820-6328-050

10000 Pcs

Accessories



Cover caps for hinge arm
→ see pages 2.177



Hinge angle restrictor
→ see page 2.175

Legend of hinge cup symbols

 Screw-on ready
← screws

EasyFix system

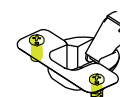

· Concealed hinge without spring for use with PushOpen mechanisms with magnet

→ see pages 2.199-2.204

Door adjustment

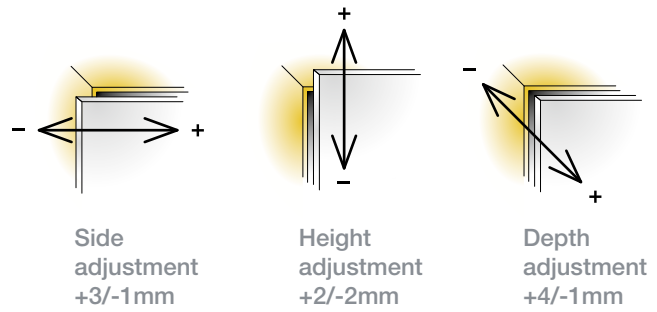

For further explanation → see pages 2.22-2.24

Mounting details

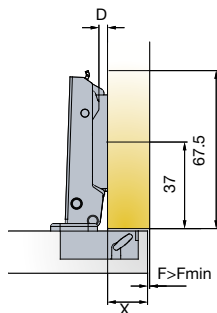
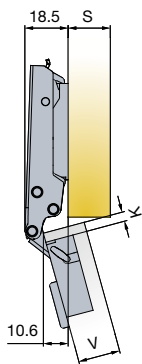

Mounting plate drilling distance

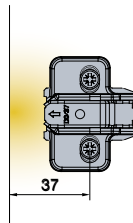

Mounting plate thickness table

For further explanation → see page 2.13

X	13	14	15	16	17	18	19
3	3	2	1	0			
4	4	3	2	1	0		
K							
5		4	3	2	1	0	
6			4	3	2	1	0
							D

$D=13+K-X$

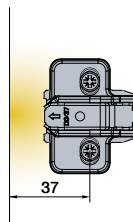
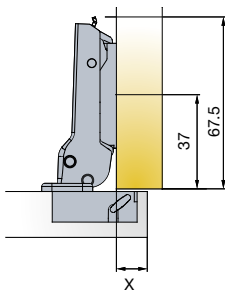
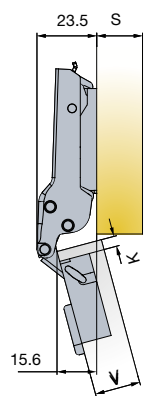

X	8	9	10	11	12	13	14
---	---	---	----	----	----	----	----

3	3	2	1	0			
4	4	3	2	1	0		
K							
5		4	3	2	1	0	
6			4	3	2	1	0
							D

$D=8+K-X$

Touch opening



PushOpen Solutions

→ see pages 2.199-2.204

Door clearance at R=1mm

For further explanation → see page 2.14

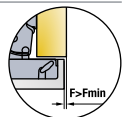

V	16	17	18	19	20	21	22	23	24	25	26
3	0.5	0.7	0.8	1	1.2	1.5	1.7	2.1	2.8	4.1	5.5
4	0.4	0.7	0.8	1	1.2	1.5	1.7	2.1	2.3	3.1	4.5
K											
5	0.4	0.6	0.7	0.9	1.1	1.4	1.6	2	2.2	2.6	3.5
6	0.4	0.6	0.7	0.9	1.1	1.4	1.6	2	2.2	2.6	2.9
											F _{MIN}

Gap Z_{MIN}=0

T-type 110 Unsprung Hinge

For wood doors

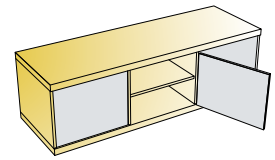
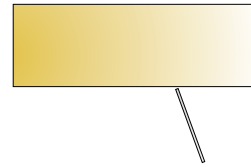
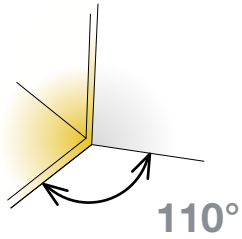



- Opening angle
- Drilling diameter for hinge cup
- Drilling depth
- Hinge on plate mounting system

110°
35mm
12mm
3Way snap-on



Technical details

	Interaxis 45mm	Interaxis 48mm
Cup type		
Item number	704-0595-054	704-0674-054
		704-0697-054

Drilling patterns for hinge cups → see page 2.17

Cranking
9mm

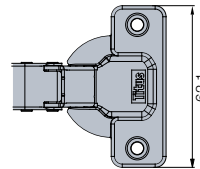
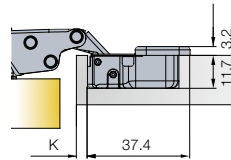
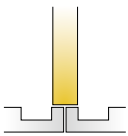

Made of steel

Mounting plates

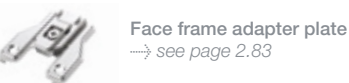
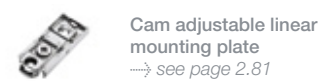

820-6328-050
10000 Pcs

Accessories



Legend of hinge cup symbols

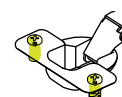
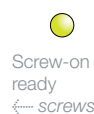

· Concealed hinge without spring for use with PushOpen mechanisms with magnet

→ see pages 2.199-2.204

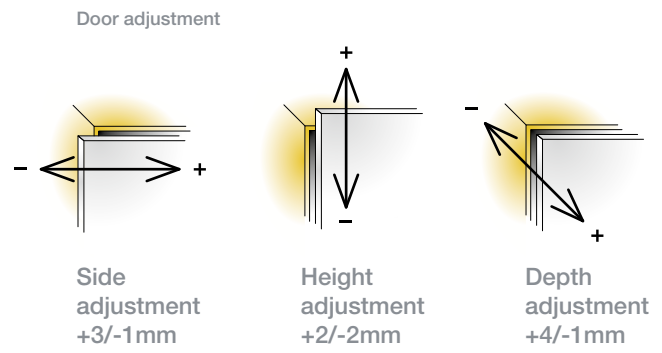

For further explanation → see pages 2.22-2.24

Mounting details

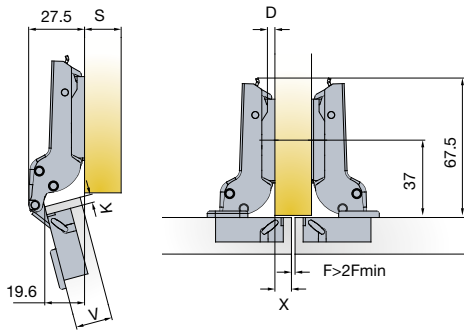

Mounting plate drilling distance

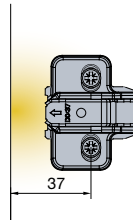

Mounting plate thickness table

For further explanation → see page 2.13

X	4	5	6	7	8	9	10
3	3	2	1	0			
4	4	3	2	1	0		
5		4	3	2	1	0	
6			4	3	2	1	0

$D=4+K-X$

Touch opening



PushOpen Solutions
→ see pages 2.199-2.204

Door clearance at R=1mm

For further explanation → see page 2.14

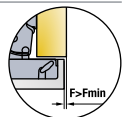

V	16	17	18	19	20	21	22	23	24	25	26
3	0.5	0.7	0.8	1	1.2	1.5	1.7	2.1	2.8	4.1	5.5
4	0.4	0.7	0.8	1	1.2	1.5	1.7	2.1	2.3	3.1	4.5
5	0.4	0.6	0.7	0.9	1.1	1.4	1.6	2	2.2	2.6	3.5
6	0.4	0.6	0.7	0.9	1.1	1.4	1.6	2	2.2	2.6	2.9 F _{MIN}

Gap Z_{MIN}=0

T-type 170

For wood doors

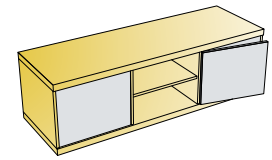
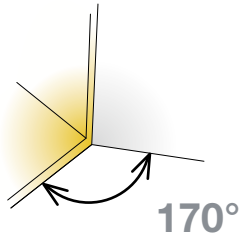



- Opening angle
- Drilling diameter for hinge cup
- Drilling depth
- Hinge on plate mounting system

165°
35mm
12mm
3Way snap-on

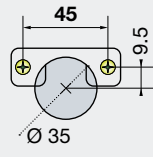

Technical details

Cup type	Interaxis 45mm	Interaxis 48mm
		 Item number: 702-0EK0-054
	Item number: 702-0EK1-054	Item number: 702-0EL1-054
	Item number: 702-0EK4-054	Item number: 702-0EL4-054

Drilling patterns for hinge cups → see page 2.17

Cranking
0mm

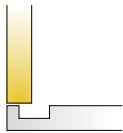

 50 Pcs

Made of steel and zinc

Mounting plates



Cam adjustable cruciform mounting plate
→ see page 2.81



Cruciform mounting plate
→ see page 2.83



Cam adjustable linear mounting plate
→ see page 2.81



Face frame adapter plate
→ see page 2.83

Hinge cup screws If not pre-mounted

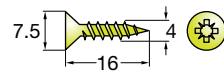

820-6328-050

 10000 Pcs

Accessories



Hinge angle restrictor
→ see page 2.175

Legend of hinge cup symbols



Screw-on ready
← screws



Machine insertion ready



EasyFix system

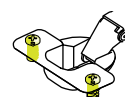
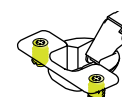
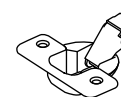

Door adjustment

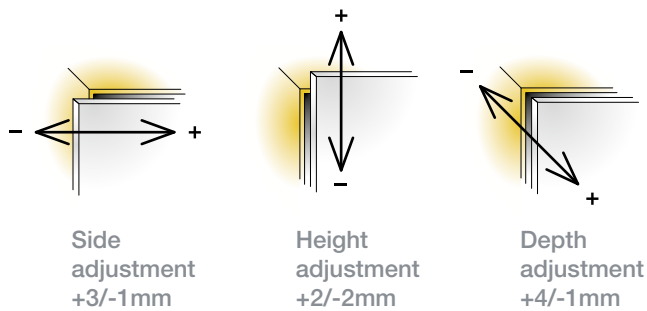

For further explanation → see pages 2.22-2.24

Mounting details

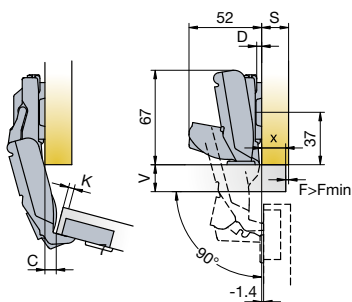

Drawings show application on D=0mm mounting plate
No door protrusion in 90° position

Mounting plate drilling distance

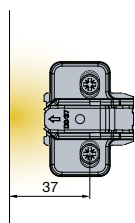

Mounting plate thickness table

For further explanation → see page 2.13

X	13	14	15	16	17	18	19
3	3	2	1	0			
4	4	3	2	1	0		
5		4	3	2	1	0	
6			4	3	2	1	0

$D=13+K-X$

Soft closing systems



Glissando TL 170
→ see page 2.191



Glissando CR
→ see page 2.195

Touch opening



PushOpen Solutions
→ see pages 2.199-2.204

Door clearance at R=1mm

For further explanation → see page 2.14

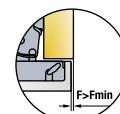

V	16	17	18	19	20	21	22	23	24
3	0.0	0.0	0.0	0.0	0.0	0.0	0.0	0.0	0.0
4	0.0	0.0	0.0	0.0	0.0	0.0	0.0	0.0	0.0
K 5	0.0	0.0	0.0	0.0	0.0	0.0	0.0	0.0	0.0
6	0.0	0.0	0.0	0.0	0.0	0.0	0.0	0.0	2.6
7	0.0	0.0	0.0	0.0	0.0	0.0	0.0	0.0	5.1

Gap Z_{MIN}=0.5

T-type 170

For wood doors

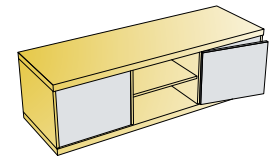
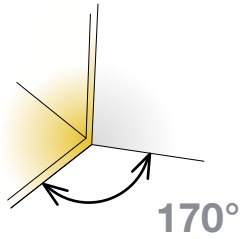

- Opening angle
- Drilling diameter for hinge cup
- Drilling depth
- Hinge on plate mounting system

165°
35mm
12mm
3Way snap-on



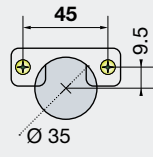
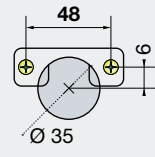

Technical details

Cup type	Interaxis 45mm	Interaxis 48mm
		
Item number		

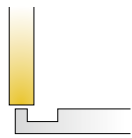
Cranking
5mm



	702-0FK0-054	702-0FL0-054
	702-0FK1-054	702-0FL1-054
	702-0FK4-054	702-0FL4-054



Drilling patterns for hinge cups → see page 2.17

 50 Pcs

Made of steel and zinc

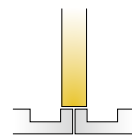
Cranking
9mm



	702-0GK0-054	702-0GL0-054
	702-0GK1-054	702-0GL1-054
	702-0GK4-054	702-0GL4-054

Drilling patterns for hinge cups → see page 2.17

 50 Pcs

Made of steel and zinc

Mounting plates



Cam adjustable cruciform mounting plate
→ see page 2.81



Cruciform mounting plate
→ see page 2.83



Cam adjustable linear mounting plate
→ see page 2.81



Face frame adapter plate
→ see page 2.83

Hinge cup screws If not pre-mounted

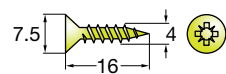

820-6328-050

 10000 Pcs

Accessories



PushOpen Solutions
→ see pages 2.199-2.204



Hinge angle restrictor
→ see page 2.175

Legend of hinge cup symbols

 Screw-on ready
← screws

 Machine insertion ready

 EasyFix system

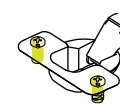
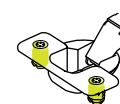
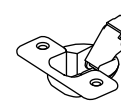

Door adjustment

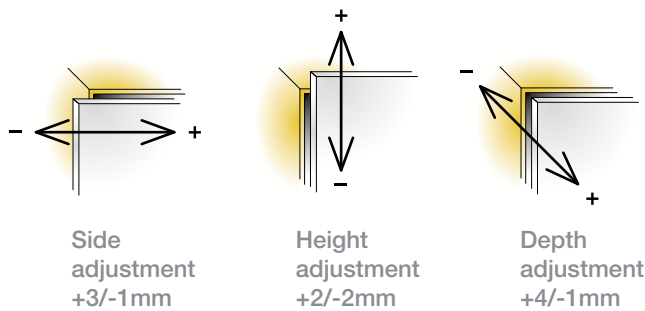

For further explanation → see pages 2.22-2.24

Mounting details

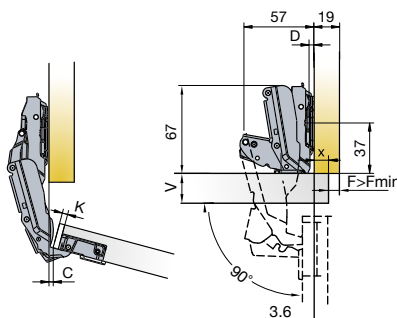

Drawings show application on D=0mm mounting plate

Mounting plate drilling distance

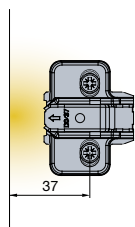

Mounting plate thickness table

For further explanation → see page 2.13

X	8	9	10	11	12	13	14
3	3	2	1	0			
4	4	3	2	1	0		
K 5		4	3	2	1	0	
6			4	3	2	1	0

$D=8+K-X$

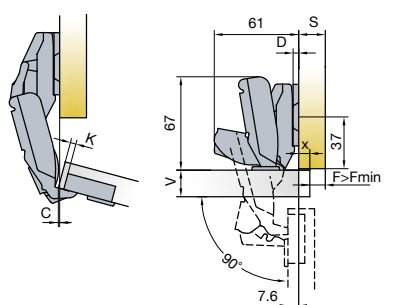

Drawings show application on D=0mm mounting plate

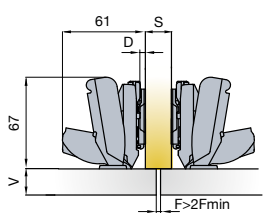

Drawing show application on D=0mm mounting plate

X 1 2 3 4 5 6 7 8 9 10 11

3	6		3	2	1	0					
4		6		3	2	1	0				
K 5			6		3	2	1	0			
6				6		3	2	1	0		
7					6		3	2	1	0	D

$D=4+K-X$

Soft closing systems



Glissando TL 170
→ see page 2.197



Glissando CR
→ see page 2.195

Touch opening



PushOpen Solutions
→ see pages 2.199-2.204

Door clearance at R=1mm

For further explanation → see page 2.14

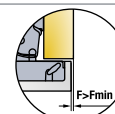

V	16	17	18	19	20	21	22	23	24
3	0.0	0.0	0.0	0.0	0.0	0.0	0.0	0.0	0.0
4	0.0	0.0	0.0	0.0	0.0	0.0	0.0	0.0	0.0
K 5	0.0	0.0	0.0	0.0	0.0	0.0	0.0	0.0	0.0
6	0.0	0.0	0.0	0.0	0.0	0.0	0.0	0.0	2.6
7	0.0	0.0	0.0	0.0	0.0	0.0	0.0	0.0	5.1

Gap $Z_{MIN}=0.5$

T-type

for Pie-cut Corner Cabinet

For wood doors

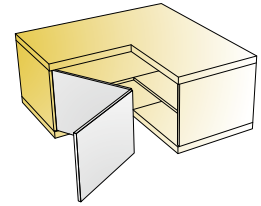

- Opening angle 70°
- Drilling diameter for hinge cup 35mm
- Drilling depth 11mm
- Hinge on plate mounting system 3Way snap-on



	Interaxis 45mm	Interaxis 48mm
Cup type	Item number	Item number
	721-0PK0-650	721-0PL0-650
	721-0PK4-650	721-0PL4-650

Corner cabinet

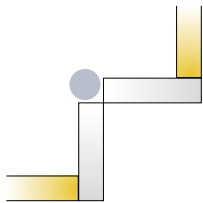

Drilling patterns for hinge cups → see page 2.17

100 Pcs Cup made of zinc, arm made of steel

Mounting plates



Cam adjustable cruciform mounting plate
→ see page 2.81



Cruciform mounting plate
→ see page 2.83



Cam adjustable linear mounting plate
→ see page 2.81

Hinge cup screws

If not pre-mounted

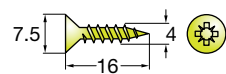

820-6328-050

10000 Pcs

Accessories



Cover caps for hinge arm
→ see page 2.177

Legend of hinge cup symbols

Screw-on ready
← screws

EasyFix

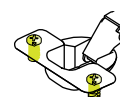
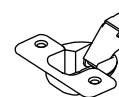

Door adjustment

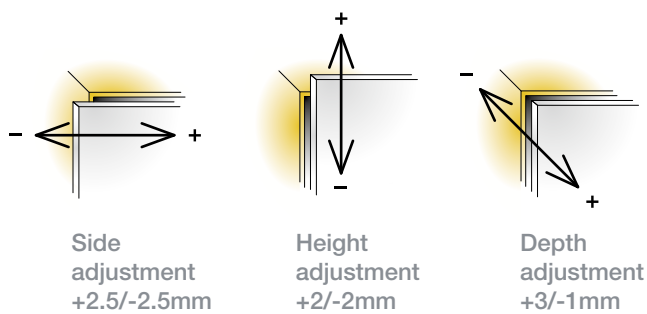

For further explanation → see pages 2.22-2.24

Mounting details

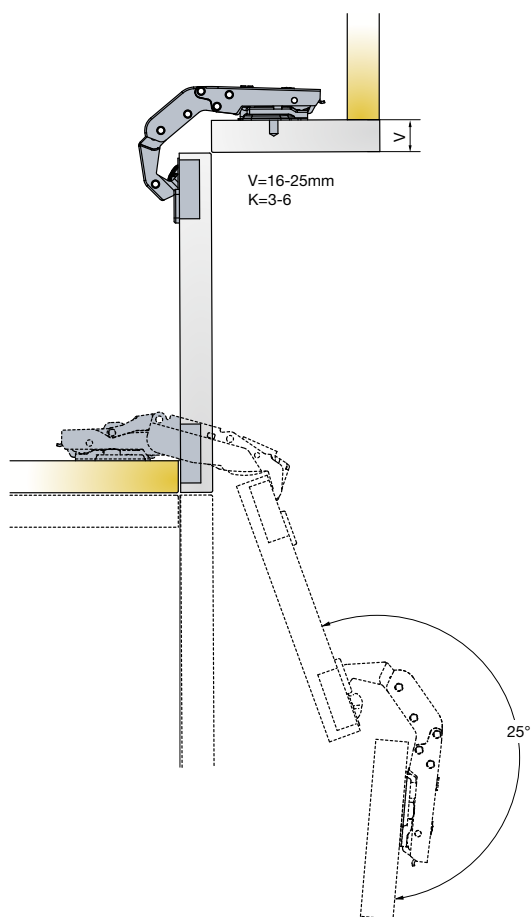

Mounting plate drilling distance

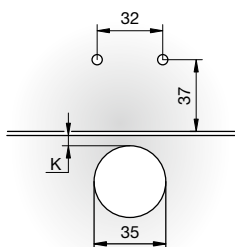

Any T-type mounting plate can be used

Adjustments

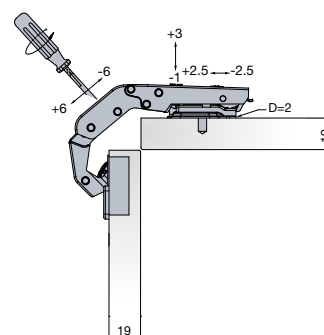

The adjustment of the gap between two doors is done by rotating the adjustment screw as shown on the drawing

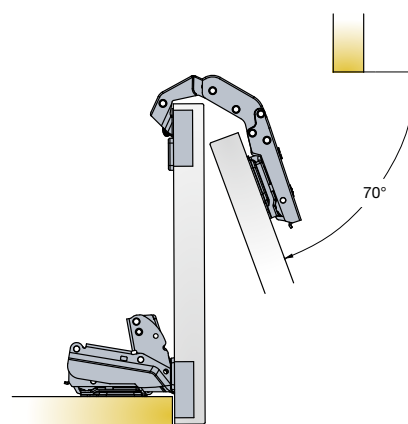

Touch opening



PushOpen Solutions
→ see pages 2.199-2.204

T-type Mounting Plates

3Way snap-on mounting

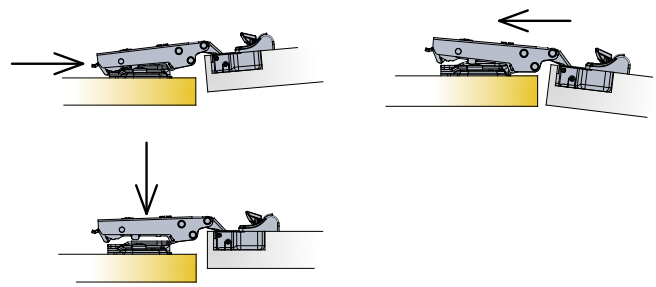

Cam adjustable cruciform
mounting plate 37mm

Drilling pattern

Dimensions

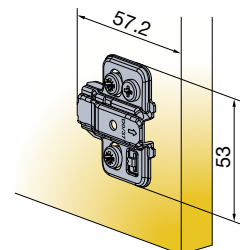
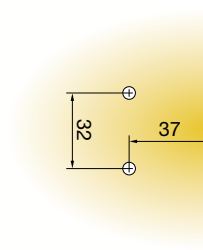

150 Pcs Made of steel

Cam adjustable linear
mounting plate

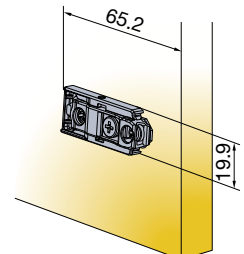
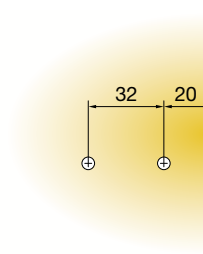

150 Pcs Made of steel and zinc

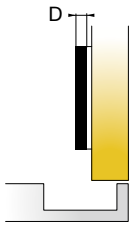

Mounting plate thickness

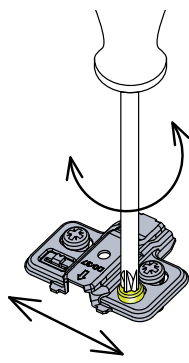

Height adjustment +2/-2mm

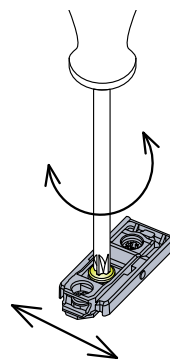

Height adjustment +2/-2mm

Mounting plate type	15		10.5	15	
Mounting plate thickness (D)					
Item number	Item number	Item number	Item number	Item number	
0mm	700-0KC0-054	700-0KB0-054	700-0KF0-054	700-0KA0-054	
1mm	700-0KC1-054	700-0KB1-054	700-0KF1-054	700-0KA1-054	
2mm	700-0KC2-054	700-0KB2-054	700-0KF2-054	700-0KA2-054	
3mm	700-0KC3-054	700-0KB3-054	700-0KF3-054	700-0KA3-054	
4mm	700-0KC4-054	700-0KB4-054	700-0KF4-054	700-0KA4-054	
0mm	700-0LC0-650	700-0LB0-650	700-0LF0-650		
2mm	700-0LC2-650	700-0LB2-650	700-0LF2-650		
3mm	700-0LC3-650	700-0LB3-650	700-0LF3-650		

Legend of mounting plate type symbols



Pre-mounted 15mm euro screws



Machine insertion ready



Pre-mounted 10.5mm expanding dowels



Pre-mounted chipboard screw

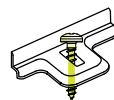
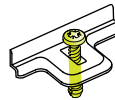
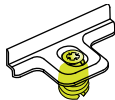
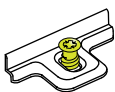

T-type Mounting Plates

3Way snap-on mounting

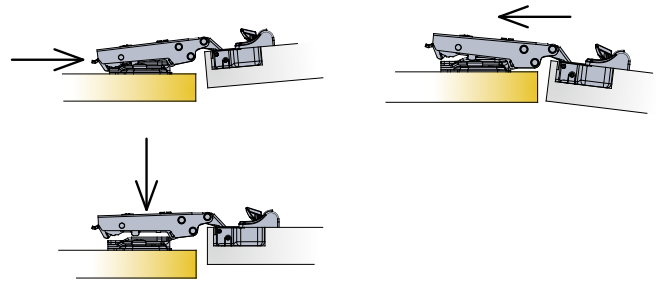

Cruciform mounting plate 37mm

Drilling pattern

Dimensions

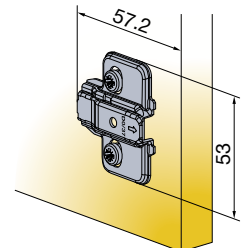
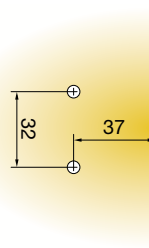

 150 Pcs Made of steel

Cam adjustable
face frame mounting plate

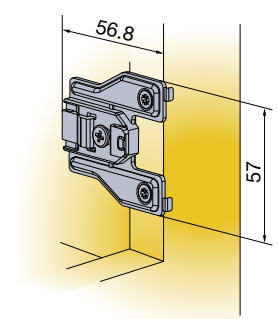
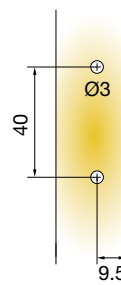

 150 Pcs Made of steel and zinc

Fixing screw for cruciform mounting plate
If not pre-mounted

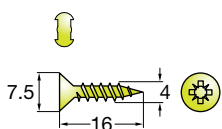

Chipboard screws
820-6328-050

 10000 Pcs

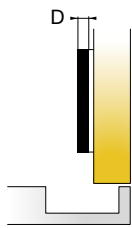

Mounting plate thickness

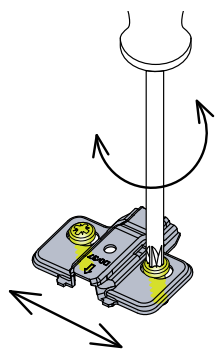



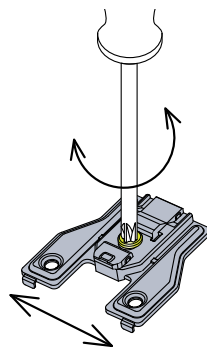



Height adjustment +2/-2mm



Height adjustment +2/-2mm

Mounting plate type		 15		 10.5	 14.5		
Mounting plate thickness (D)							
Item number	Item number	Item number	Item number	Item number	Item number	Item number	
0mm	700-0NA0-054	700-0NC0-054	700-0NB0-054	700-0NF0-054	700-0NE0-054		
1mm	700-0NA1-054	700-0NC1-054	700-0NB1-054	700-0NF1-054	700-0NE1-054		
2mm	700-0NA2-054	700-0NC2-054	700-0NB2-054	700-0NF2-054	700-0NE2-054		
3mm	700-0NA3-054	700-0NC3-054	700-0NB3-054	700-0NF3-054	700-0NE3-054		
4mm	700-0NA4-054	700-0NC4-054	700-0NB4-054	700-0NF4-054	700-0NE4-054		
0mm						700-0KW0-054	
3mm						700-0KW3-054	

Legend of mounting plate type symbols

	 15		 10.5	 15	 14.5
Screw-on ready for chipboard screws ← screws	Pre-mounted 15mm euro screws	Machine insertion ready	Pre-mounted 10.5mm expanding dowels	Pre-mounted chipboard screw	Pre-mounted chipboard screw
